

LEHSVG High Voltage Dynamic Power Compensation

Operation Manual

Lafaelt
LAFELT ELECTRIC

Preface

Thank you for using the LEHSVG series of products independently developed by our company.

This manual is applicable to cascaded high-voltage dynamic reactive power compensation devices with voltage levels of 6 ~ 35kV. For safe and reliable use of this high-voltage

It is strongly recommended that you read the contents of this manual thoroughly and pay special attention to the safety regulations and warnings.

The current version is V3.0. If the subsequent user manual has a version update, please refer to the latest user manual.

This manual mainly introduces the product in several parts. You can find relevant content according to your needs:

Safety instructions	Chapter 1 Safety Instructions
Initial understanding of LEHSVG products	Chapter 2 LEHSVG Overview
Introduction to the simple principles of LEHSVG and related cabinet knowledge	Chapter 3 LEHSVG Product Introduction Chapter 4 LEHSVG device structure
LEHSVG Touch Screen Interface Instructions	Chapter 5 Introduction to Touch Screen (HMI)
LEHSVG Storage and Handling Instructions	Chapter 6 Storage and Installation
LEHSVG daily operation startup and shutdown instructions	Chapter 7 LEHSVG debugging and use
LEHSVG Maintenance Precautions	Chapter 8 LEHSVG Maintenance Precautions
LEHSVG common troubleshooting	Chapter 9 Frequently Asked Questions
LEHSVG After-Sales Service Policy Description	Chapter 10 Service and Warranty

if you have any questions about the contents of the manual, you can contact our company through the following methods.

Jiangsu Lafaelt Electric Co., Ltd.

Service hotline: 400-882-1973

Inquiry phone number: 021-60393355

Inquiry email: Marketing@lafaelt.com

Fax: 021-60393857

Website: www.lafaelt.com

Address: No. 79 Qunxing Road, Xinwu District, Wuxi City, China

Table of contents

Chapter 1 Safety Instructions	5
1.1 Operating Instructions.....	5
1.2 Transportation and storage instructions.....	6
1.3 Debugging instructions.....	7
1.4 Operation instructions.....	7
1.5 Maintenance instructions.....	8
1.6 Other instructions.....	8
Chapter 2 LEHSVG Overview	9
2.1 Overview.....	9
2.2 LEHSVG design specifications.....	11
2.3 LEHSVG series product features.....	12
Chapter 3 LEHSVG Product Introduction	14
3.1 Basic principles of LEHSVG reactive power compensation.....	14
3.2 Main technical parameters of LEHSVG.....	15
3.3 LEHSVG models and specifications.....	16
Chapter 4 LEHSVG device structure	17
4.1 LEHSVG system structure.....	17
4.2 Power cabinet.....	20
4.3 Reactor cabinet.....	23
4.4 Control cabinet.....	24
4.5 Cooling system.....	27
Chapter 5 Introduction to Touch Screen (HMI)	30
5.1 HMI system framework.....	30
5.2 HMI page function introduction.....	30
5.3 Introduction to HMI use.....	31
Chapter 6 Storage and Installation	36
6.1 Overview.....	36
6.2 Acceptance.....	36
6.3 Storage.....	36
6.4 Mechanical installation.....	37

6.5 Electrical installation.....	40
6.6 Fire protection requirements.....	43
6.7 Lightning protection and other requirements.....	43
Chapter 7 Debugging and using LEHSVG.....	44
7.1 Overview.....	44
7.2 Precautions for starting and stopping LEHSVG.....	44
7.3 LEHSVG startup and shutdown operation steps.....	45
7.4 LEHSVG operation mode.....	49
Chapter 8 LEHSVG Maintenance Precautions.....	50
8.1 Daily inspection items.....	51
8.2 Regular maintenance items.....	52
Chapter 9. Handling of Frequently Asked Questions.....	55
9.1 Overview.....	55
9.2 Frequently Asked Questions and Solutions.....	55
9.3 How to replace a faulty unit.....	56
Chapter 10 Service and Warranty.....	58

Chapter 1 Safety Instructions





The following "Danger", "Warning" and "Caution" are provided for your safety and to prevent the equipment and its related parts from being damaged.

Some measures taken. When dealing with matters related to high-voltage dynamic reactive power compensation devices, the "dangers" and "warnings" listed in this section are usually involved.

Warnings" and "Cautions", which are divided into the following categories: transportation and storage, commissioning, operation, maintenance and disassembly related.

Please read these "Dangers," "Warnings," and "Cautions" carefully as they provide assurance for your personal safety and may help prolong

The service life of high-voltage dynamic reactive power compensation device.

 <p>Danger</p>	<p>Indicates that failure to follow this instruction or improper operation is likely to result in death, serious injury or serious injury. Large property damage content.</p>
 <p>warn</p>	<p>Indicates that failure to follow this instruction or improper operation may result in death, serious injury, or equipment damage. Corrupted content.</p>
 <p>Notice</p>	<p>Indicates that failure to follow this instruction or improper operation may result in personal injury and possible Content that causes damage to items.</p>
 <p>Prevent static electricity</p>	<p>Indicates that electrostatic protection is required here, otherwise electronic components may be damaged and equipment failure may occur.</p>

1.1 Operating Instructions

 <p>Danger</p>
<ul style="list-style-type: none"> • This equipment is high-voltage equipment. High-voltage operations must be carried out according to correct procedures. The user shall designate specialized high-voltage operators on site, otherwise death, serious personal injury or significant property damage may occur. • After disconnecting the contactor/circuit breaker of the SVG equipment, the primary circuit such as the power unit still carries high voltage. When repairing the SVG equipment, the SVG's power distribution cabinet must be cut off and the trolley must be rolled out! • Be aware of the risk of electric shock. Even if the high-voltage power supply has been cut off, there is still dangerous DC voltage remaining on the DC busbar and the capacitor of the high-voltage dynamic reactive power compensation device, so high-voltage dynamic reactive power compensation cabinet door is only allowed to be opened after 15 minutes since the high-voltage power is cut off. To use testing equipment to detect that the residual energy of the DC side capacitor in the power unit has been discharged before touching DC side capacitors and related connecting copper bars of the power unit. • Be aware of the risk of electric shock. The control power supply of the control system is rectified from alternating current to direct current. When the control system is powered off, the DC capacitor still remains the DC voltages , so inspection and maintenance of the control system is not allowed until 15 minutes after the control system has been powered off.

- Be aware of the risk of electric shock. If the grounding fails, the connecting part or system failure may result in phase loss between the cabinet shell and ground. A voltage difference of such magnitude that contacting the shell and ground at the same time may result in serious injury or even death

**Notice**

The term "certified personnel" in this manual refers to:

- Have received special training and passed the examination, and can operate circuits and equipment in accordance with the requirements of conventional and safe operating procedures specified in this manual. Perform various operations such as powering on, powering off, cleaning, grounding, and wiring connections.
- Be trained to correctly maintain and use the equipment in accordance with the requirements of conventional and safe operating procedures specified in this manual.
- Be trained in first aid.

- Please place this manual in an easy-to-find place near the equipment to ensure that all users can use it easily.
- If you want to perform measurements or tests on live equipment that is in operation, you must comply with relevant safety regulations. Appropriate electronic equipment should be used accordingly.
- Before installing and debugging the high-voltage dynamic reactive power compensation device, please be sure to carefully read these safety rules and warnings, as well as all the warning signs on the equipment. Ensure warning signs are prominently displayed and replace signs that have become detached or damaged.

1.2 Transportation and storage instructions

**Notice**

If on-site installation is not carried out immediately after completing the delivery acceptance work, the equipment must be stored in accordance with the requirements of this section. Equipment with outer packaging should be stored in a ventilated, dry, and tidy environment. Meanwhile, the following points should also be noted:

- Restore the packaging to its original state, and the desiccant inside the packaging must be retained and not discarded.
- The storage ground is flat and sufficient to bear the weight of the equipment with outer packaging.
- When storing equipment, attention should be paid to ventilation and moisture prevention, and it is strictly prohibited to store water in the environment.
- Storage temperature: $-30\sim+70\text{ }^{\circ}\text{C}$; Relative humidity: The monthly average value should not exceed 90% ($25\text{ }^{\circ}\text{C}$), with no condensation.
- Pay attention to dealing with harsh environments around, such as sudden cooling, heating, collisions, etc., to avoid damage to the equipment.
- Regular inspections, generally not less than once a week. Check if the packaging is intact and undamaged to avoid insect and rodent bites. If there is any damage to the outer packaging, then the packaging should be replaced immediately.

- If the storage time exceeds half a year, the package should be opened for inspection, the desiccant should be replaced and then repackaged.

1.3 Debugging instructions



- Untrained and qualified personnel working on the components/systems of this equipment or failing to comply with the relevant regulations in the warning may cause serious personal injury or significant property damage. Only certified and qualified professionals who have received training in the design, installation, commissioning, and operation of the equipment are allowed to work on the components/systems of this equipment.
- The input power cord is only allowed to be permanently fastened. The equipment must be grounded (according to IEC 536 Class 1, NEC and other applicable standards)
- Even if the high-voltage dynamic reactive power compensation device is not in operation, the following terminals may still carry dangerous voltage:
 - High voltage power input terminals
 - The DC busbar inside the cabinet and the connected DC capacitors.



- The power cables and control cables connected to this equipment must be connected according to the requirements in the user's drawings in order to avoid interference caused by the operation of the high-voltage dynamic reactive power compensation device.

1.4 Operation instructions



- High-voltage dynamic reactive power compensation device operates under high pressure.
- When the high-voltage dynamic reactive power compensation device is in operation, dangerous voltages inevitably exist on some of its components.
- To ensure that the high-voltage dynamic reactive power compensation device can achieve good compensation effect, it is necessary to input the parameters of the operating site through the touch screen display interface, such as the voltage transformer and current transformer ratio configured by the user, which must be completely consistent with the actual situation.
- The site needs to be well ventilated, and the high-pressure dynamic reactive power compensation device fan should start normally to achieve good heat dissipation effect and prevent the system from overheating or even catching fire.

1.5 Maintenance instructions



- Equipment maintenance can only be carried out by our company's service department, authorized repair centers, or certified and authorized personnel. These personnel should be very familiar with all the warnings raised in this manual and the correct operating steps; Any defective components and devices must be replaced with the same components;
- Before opening the cabinet door of our company's products for maintenance, it is necessary to first disconnect the high voltage, disconnect the high voltage for 15 minutes, and then disconnect the control power. Only after the high voltage is cut off for 15 minutes, can the cabinet door of the high voltage dynamic reactive power compensation device be opened. Use testing equipment to detect that the residual energy of the DC side capacitor in the power unit has been discharged before touching the DC side capacitor and related connecting copper bars of the power unit.

1.6 Other information



- Keep children and the public away from or near this device!
- This device can only be used for the purposes specified by the manufacturer. Unauthorized modification or use of spare parts not sold or recommended by the equipment manufacturer may result in fire, electric shock, or other injuries.

Chapter 2 LEHSVG Overview

2.1 Overview

With the large-scale development of modern power grids, the widespread application of non-linear and impact loads such as new energy grid connection, steel metallurgy, electrified railways, etc., has brought serious power quality problems:

- The power factor is low, the grid loss increases, the production cost increases, and the production efficiency decreases.
- The generated reactive power impact causes power grid voltage fluctuations and flickers, which in severe cases may cause the transmission device and protection device to fail to work normally even stop the production.
- The three-phase power grid is unbalanced, resulting in negative sequence current causing the motor rotor to vibrate.
- Generate high-order harmonic currents, causing grid voltage distortion.
- Capacitor bank resonance and harmonic current amplification can cause capacitors to be overloaded or overvoltage, or even burned out.
- Increase transformer loss and cause transformer heating.
- Causes the power equipment to heat up and the motor torque to be unstable or even damaged.
- Accelerates the aging of the insulation of electrical equipment and makes it prone to breakdown.
- Reduce the production efficiency of electric arc furnace and increase losses.
- Interference with communication signals.

With the continuous development of the power grid, the need to control and compensate reactive power is increasing day by day.

The most ideal solution currently is to use LEHSVG (Static Var Generator), also known as STATCOM (Static Synchronous Compensator). Its main function is to improve power grid stability, increase transmission capacity, eliminate reactive power shocks, suppress harmonics, balance three-phase power grids, reduce losses, and save energy and emissions.

Compared to traditional SVC compensation devices, LEHSVG has obvious advantages such as fast response time, small footprint, and suitability for compensation in various situations.

The LEHSVG series products can enhance power transmission capacity, reduce energy loss, compensate reactive power, control harmonics, suppress flicker, stabilize grid voltage, balance three-phase systems, change damping characteristics of systems, and improve system stability, with a wide range of applications.

The LEHSVG series products can be widely used in industries such as new energy, petrochemicals, power systems, metallurgy, electrified railways, and urban construction, providing high-quality services for various wind turbines, frequency converters, asynchronous motors, transformers, thyristor converters, elevators, cranes, stamping machines, welding machines, steel mills, electric arc furnaces, induction furnaces, resistance furnaces, quartz smelting furnaces, electric locomotives, and other equipment A highly reliable solution for reactive power compensation.

Application industry	LEHSVG application features
Wind power photovoltaic, etc. new energy industry	Control reactive power at power access points of wind power and photovoltaic power generation equipment to prevent reactive power backflow
	Stabilize the grid voltage and reduce voltage fluctuations caused by power generation fluctuations
	Maintain access point voltage and improve low voltage ride through capability
	Compensating for harmonics to improve power quality
Urban distribution network and rural power supply	Improve power factor and reduce reactive power loss
	Addressing voltage fluctuations and flickers caused by fluctuating loads
	Stable voltage at the receiving end
	Suitable for centralized compensation of reactive power and harmonics for multiple users, especially in situations with high impulse loads
electrified railway and urban rail transit	Comprehensive management of reactive power and harmonics in traction power supply systems, improving power quality, enhancing traction capacity, energy conservation and consumption reduction
	Compensating for negative sequence current generated by locomotive load
Steel and metallurgical industry	Improve power factor and reduce reactive power loss
	Reduce voltage fluctuations, suppress flicker, and improve production efficiency
	Filter out harmonics to ensure equipment safety
	Balancing load
Petroleum, chemical industry, mining mountain, wharf, heavy	Stable the voltage supply
	Centralized compensation for substations that supply power to a large number of medium and low voltage motors
	On site dynamic compensation of reactive power for large motors
	Concentrated reactive power compensation for various types of crushers, crushers, and ball mills
	Reduce reactive power fluctuations and harmonics in traction transmission devices
	Centralized compensation for large crane equipment, ship lock control system, forging equipment, etc

2.2 LEHSVG design specifications

LEHSVG series products meet the following main standards or provisions related to the provisions of these standards.

GB/T 311.1-2012 Insulation coordination Part 1: Definitions, principles and rules

GB/T 2900.1-2008 Basic terminology for electrical engineering

GB/T 2900.32-1994 Electrical terminology power semiconductor devices

GB/T 2900.33-2004 Electrical terminology Power electronics technology (IEC 60050-551: 1998, IDT)

GB/T 3797-2016 Electrical control equipment

GB/T 4208-2017 Enclosure protection level (IP code)

GB/T 5169.10-2017 Fire hazard test for electrical and electronic products Part 10: Glow wire/Hot wire basic test method Glow Wire Apparatus and General Test Methods

GB/T 5169.11-2017 Fire Hazard Test for Electrical and Electronic Products Part 11: Glow Wire/Hot Wire Basic Test Method Finished Products Glow Wire Flammability Test Method (GWEPT)

GB/T 7251.1-2013 Low-voltage switchgear and control equipment Part 1: General provisions

GB/T 7261-2016 Basic test methods for relay protection and safety automatic devices

GB/T 9969-2008 General principles for instructions for use of industrial products

GB/T 12325-2008 Power quality supply voltage deviation

GB/T 12326-2008 Power quality voltage fluctuation and flicker

GB/T 12668.3-2012 Speed-regulated electrical drive systems Part 3: Electromagnetic compatibility requirements and specific test methods

GB/T 14549-1993 Power quality public grid harmonics

GB/T 14598.3-2006 Electrical relays Part 5: Insulation requirements and tests for measuring relays and protective devices

GB/T 14598.27-2008 Measuring relays and protective devices Part 27: Product safety requirements

GB/T 15543-2008 Power quality three-phase voltage imbalance

GB/T 15945-2008 Power quality power system frequency deviation

GB/T 18481-2001 Power quality temporary overvoltage and transient overvoltage

GB/T 15576-2008 Low-voltage complete reactive power compensation device

GB/T 17626.2-2018 Electromagnetic compatibility testing and measurement technology electrostatic discharge immunity test

GB/T 17626.3-2016 Electromagnetic compatibility testing and measurement technology Radio frequency electromagnetic field radiation immunity test

GB/T 17626.4-2018 Electromagnetic compatibility test and measurement technology Electrical fast transient burst immunity test

GB/T 17626.5-2019 Electromagnetic compatibility testing and measurement technology surge (impact) immunity test

GB/T 17626.11-2008 Electromagnetic compatibility test and measurement technology Immunity test for voltage dips, short interruptions and voltage changes

GB/T 17626.12-2013 Electromagnetic compatibility testing and measurement technology ringing wave immunity test

DL/T 1216-2013 Technical Specification for Distribution Network Static Synchronous Compensation Device

DL/T 620-1997 Overvoltage protection and insulation coordination of AC electrical installations

DL/T 672-2017 Technical conditions for use of voltage and reactive power regulation and control systems for substations and distribution lines

NB/T 42043-2014 High voltage static synchronous compensation device

JB/T 5777.2-2002 General technical conditions for control and relay protection (cabinets and stations) of secondary circuits in power systems

2.3 LEHSVG series product features

Our company's LEHSVG series products adopt modern power electronics, automation, microelectronics, and network communication technologies, advanced instantaneous reactive power theory, and power decoupling algorithm based on synchronous coordinate transformation. They operate with set reactive power properties and sizes, power factors, and grid voltage as control objectives, dynamically tracking changes in grid power quality to adjust reactive power output, and can achieve curve setting operation to improve grid quality.

Our company's LEHSVG dynamic reactive power compensation device is a reactive power compensation system with IGBT as the core, which can quickly and continuously provide capacitive or inductive reactive power, achieve control of constant reactive power, constant voltage, and constant power factor at assessment points, and ensure stable, efficient, and high-quality operation of the power system.

The LEHSVG series products, which are easy to operate, high-performance, and highly reliable, have been designed to meet the urgent needs of users to improve the power factor, control harmonics, and compensate for negative sequence currents in transmission and distribution networks. They have the following characteristics:

high performance	Fast dynamic response, response time $\leq 5\text{ms}$
	Under rated operating conditions, output current harmonics (THD) $\leq 3\%$

	<p>LEHSVG circuit parameters are carefully designed, with low heat generation, high efficiency and low operating cost.</p> <p>The main circuit adopts an H-bridge power unit chain series structure composed of IGBT, with multiple identical power units in each phase. The output of the entire machine is a stepped wave formed by the superposition of PWM waveforms, approaching sine. After output reactance filtering, the sine degree is good</p> <p>The protection function is complete, with protection for overvoltage, undervoltage, overcurrent, unit overheating, uneven voltage, etc., and can achieve waveform recording of fault moments, making it easy to determine the fault point, easy to maintain, and high operational reliability</p>
Structure	The equipment has a compact structure and a small footprint.
Easy to operate	<p>The human-machine interface is user-friendly and provides interfaces such as RS485 and Ethernet for external communication. It adopts the standard Modbus communication protocol, which not only has functions such as real-time display of digital and analog quantities, operation history event recording, historical curve recording query, unit status monitoring, system information query, and historical fault query, but also has special functions such as system self check after power transmission, one key on/off, time-sharing control, oscilloscope (AD channel forced waveform recording), and voltage/current waveform recording at the moment of fault</p>
	<p>Multiple operating modes greatly meet user needs, including constant device reactive power mode, constant assessment point reactive power mode, constant assessment point power factor mode, constant assessment point voltage mode, etc. The target value can be changed in real time</p>
	<p>The LEHSVG design includes interfaces for use in conjunction with FC, achieving an effective combination of fixed compensation and dynamic compensation, providing users with more economical and flexible compensation solutions</p>
	<p>Can be installed in parallel, easy to expand capacity, and uses fiber optic communication for parallel operation. The communication speed is fast and can meet the requirements of real-time compensation</p>
Easy to maintain	Adopt redundant design to meet the high reliability of the system and the convenience of maintenance
	Modular design of power circuit, simple maintenance and good interchangeability
	No transient impact during switching, no closing surge

Chapter 3 LEHSVG Product Introduction

3.1 Basic principles of LEHSVG reactive power compensation

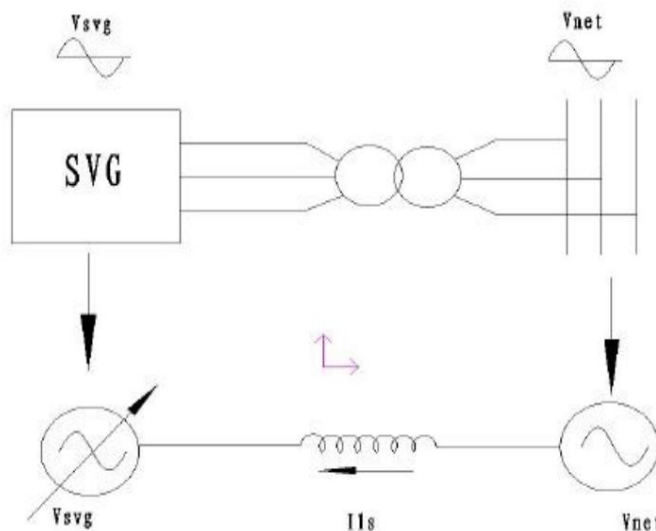

Figure 3.1 Principle diagram

The schematic diagram of the LEHSVG series products is shown in Figure 3.1. In AC circuits, there are three situations where the phase of voltage and current is the same. When the load exhibits pure resistance characteristics, the phase of voltage and current is the same; When the load exhibits inductive characteristics, the voltage phase leads the current phase; When the load exhibits capacitive characteristics, the voltage phase lags behind the current phase.

The basic principle of the LEHSVG series products is to connect a self commutating bridge circuit in parallel to the power grid through a transformer or reactor, adjust the amplitude and phase of the AC side output voltage of the bridge circuit appropriately, or directly control its AC side current to absorb or emit reactive current that meets the requirements, achieving the purpose of dynamic reactive power compensation, as shown in Table 3.1.

Table 3.1 Operating mode principle table

operating mode	waveform	Phase	illustrate
No-load operation mode			If $V_{SVG} = V_{net}$, then $I_{Is} = 0$, which is equivalent to a resistor with adjustable resistance.
Perceptual operating mode			If $V_{SVG} < V_{net}$, then I_{Is} is the hysteresis current. Equivalent to a continuously adjustable inductor

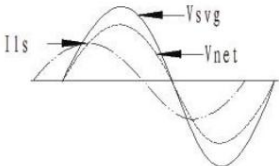
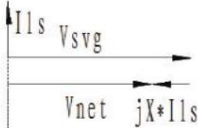
capacitive operating mode			<p>If $V_{SVG} > V_{net}$, then I_s is the leading current. Equivalent to a continuously adjustable capacitor</p>
---------------------------	---	--	--

3.2 LEHSVG main technical parameters

name	content
Rated voltage	6kV±10% ~ 35kV±10%
Assessment point voltage	6kV±10% ~ 500kV±10%
Input voltage	0.9 ~ 1.1pu
Low voltage ride through	0pu (150ms) 0.2pu(625ms)
High voltage ride through	1.2~1.3pu(Can be set as 1s)
System frequency	50Hz/60Hz
Output capacity	±0.1Mvar ~ ±200Mvar
Response time	full response time≤5ms
Overload capacity	≥120% (1min)
Total harmonic distortion (THDi)	≤3%
Reactive power adjustment mode	Capacitive and intuitive automatic continuous smooth adjustment
Communication interface	Ethernet, RS485, CAN, high-speed fiber optic communication interface
Communication protocol	MODBUS_RTU、Profibus、Electric CDT91 protocol、IEC60870-5-104
Operation mode	Constant device reactive power mode, constant assessment point reactive power mode, constant assessment point power factor mode, constant assessment point voltage mode, etc. The target value can be changed in real time
Parallel mode	Multi machine parallel networking operation, multi bus comprehensive compensation, and multi group FC comprehensive compensation control

Protective function	Bus overvoltage, bus undervoltage, LEHSVG overcurrent, drive fault, power unit Overvoltage, overcurrent, unit overtemperature; protection input interface, protection output interface, System power supply abnormality and other protection functions.
Fault handling	Adopting redundant design to meet N-1 operation
Cooling method	air cooling/water cooling
Protection grade	indoor IP30, outdoor IP44
Storage temperature	-30℃ ~ +70℃
Operating temperature	indoor -10℃ ~ +40℃, outdoor -25℃ ~ +40℃
relative humidity	Monthly average value not exceeding 90% (25℃), no condensation
Earthquake intensity	VIII
Pollution level	IV

Note: Please refer to the specific model of the device for the above parameters.

3.3 LEHSVG models and specifications

The model naming rules of LEHSVG series products are shown in Figure 3.3:

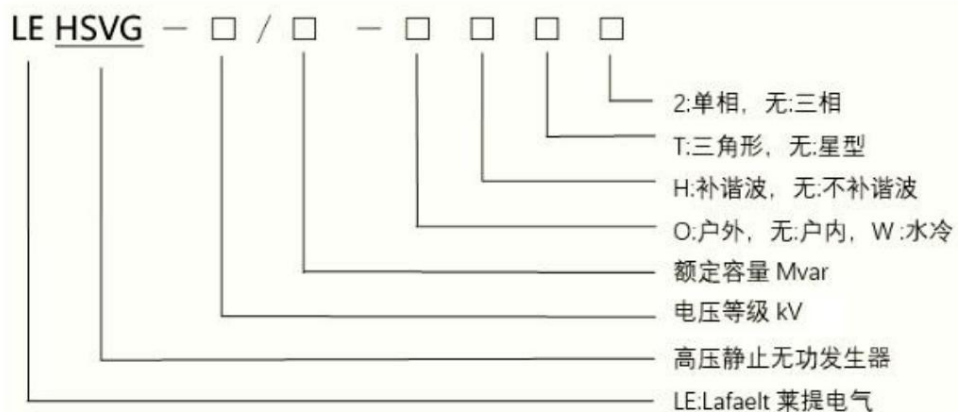

Figure 3.3 Product naming rules

Note: Capacity (Mvar) represents the rated maximum regulation capacity within the dynamic regulation range from inductive reactive power to capacitive reactive power. For example, LEHSVG-10/2 represents a direct mounted 10kV device with a capacity of 2Mvar. Capable of continuously smoothing reactive power within the range of 2000kvar (inductive) to 2000kvar (capacitive).

Chapter 4 LEHSVG device structure

4.1 LEHSVG system structure

The main circuit of the LEHSVG series products adopts a chain topology structure, modular structural design, and star and triangle connection methods to achieve maximum cost-effectiveness under different capacities, ensuring the effectiveness of user investment and stable, efficient, and high-quality operation of the power system. The schematic diagram of the star connection method is shown in Figure 4.1.

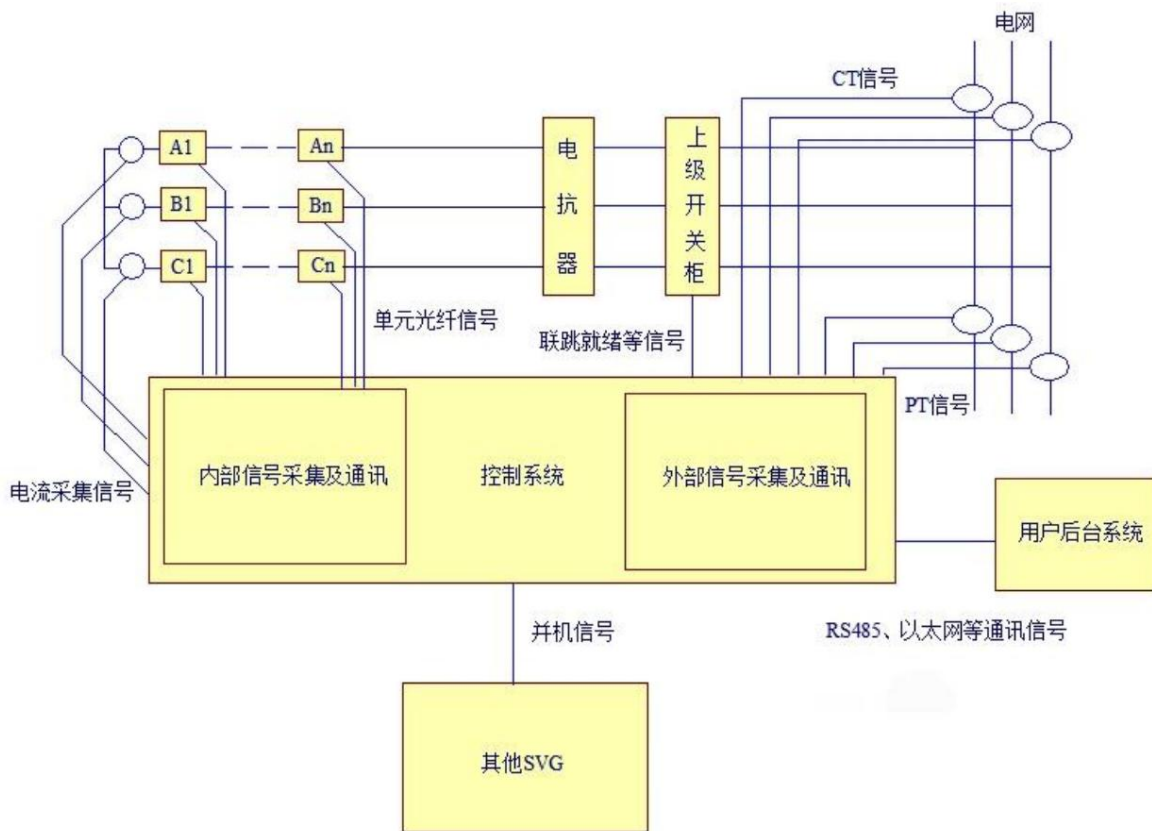

Figure 4.1 Schematic diagram of LEHSVG electrical structure

The control box and power unit signals are isolated and controlled through optical fibers, achieving reliable isolation of high and low voltage. The LEHSVG series product system has made significant structural improvements, making maintenance more convenient. The control cabinet has undergone strict anti-interference treatment to ensure that the control system is not affected by the high-voltage main circuit. The improvement of power modules (units) leads to a smaller footprint of the power cabinet, greatly saving user equipment space and reducing investment.



Figure 4.2 6-10kV indoor high voltage model (for reference only)



Figure 4.3 6-35kV outdoor container model (for reference only)



Figure 4.4 35kV indoor water-cooled corner connection model (for reference only)



Figure 4.5 LEHSVG prefabricated cabin model (for reference only)

The LEHSVG series products are mainly divided into four parts: control cabinet, power cabinet, reactor cabinet (if using a hollow core reactor, this cabinet is not available), and heat dissipation system. The power cabinet achieves great uniformity, facilitating the expansion and stability of product capacity. The main components and their functions in each cabinet are shown in Table 4.1.

Table 4.1 10kV LEHSVG main components and functions

system structure	Main device classification	effect
Control cabinet	switching device	Main circuit switching and disconnection
	Buffer device	Bus buffering during module charging

	Data acquisition device	Switch value and analog quantity acquisition
	control box	data processing
	logic controller	logic control
	HMI	Set and display parameters and record waveforms
	Secondary power system	Process the power supply to achieve stability of the control system
Power cabinet	Power unit	The signal is cascaded into a voltage with a specific amplitude and phase.
	Forced air cooling system /Cooling system	Forced cooling of modular units
Reactor cabinet	Reactor	Realize grid connection of reactive voltage sources and filter current
Cooling system	Water cooling control cabinet	Provide water cooling cycle power and monitor the operation of the water cooling system in real time
	water air heat exchanger	The heat-carrying medium enters the water-air heat exchanger and is taken away by the forced air. To achieve the purpose of heat exchange

4.2 Power cabinet

The power cabinet is mainly composed of power units, which constitute the main body of LEHSVG reactive power compensation. The power unit is installed in three phases, with equal numbers of units in each phase. The output waveform of the units is superimposed into the overall output waveform of the machine. Each power unit bears all output currents, $1/N$ phase voltage, and $1/(3N)$ output power. During the operation of unit modules, some heat is generated, which is forcibly dissipated by fans designed on the top or back cabinet doors, or by using a water-cooling system. The layout of air-cooled power cabinet units is shown in Figure 4.6, and the layout of water-cooled air-cooled power cabinet units is shown in Figure 4.7.



Figure 4.6 Arrangement of units in air-cooled power cabinet



Figure 4.7 Arrangement of units in water-cooled power cabinet

The power unit (see Figure 4.8) is equipped with various circuit boards. In addition to the sampling circuit, protection circuit, and output drive circuit, all logic and communication processing in the unit control section are completed using large-scale CPLD chips. The intelligent design makes the hardware simpler, the software more flexible, the anti-interference ability stronger, and the reliability higher, making it easier for future functional improvements and upgrades.

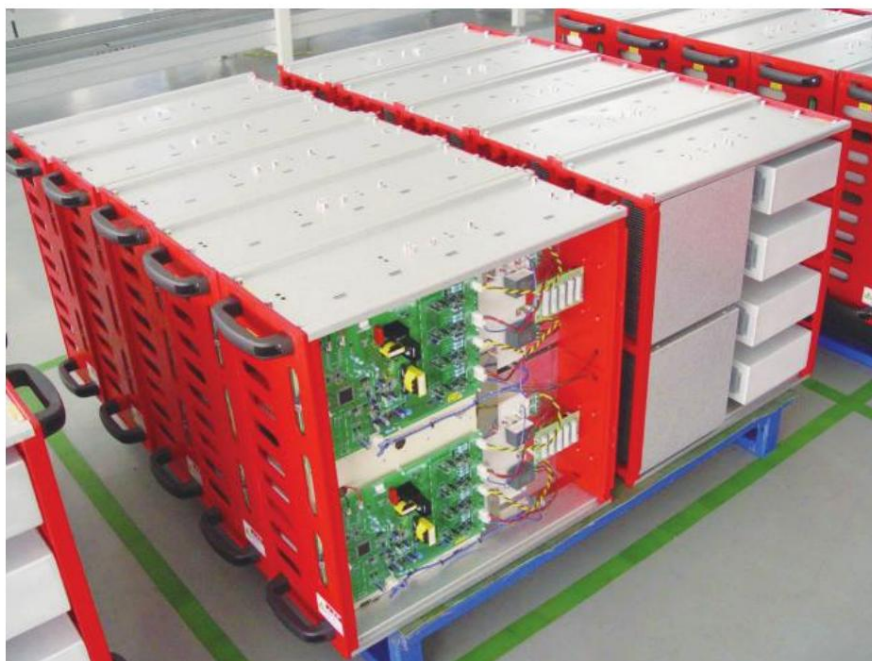

Figure 4.8 Power unit (module)

DC capacitors are carefully selected from well-known brands of thin film capacitors and special vapor deposition materials, which not only meet the requirements of high voltage and high current shocks but also have good self-healing properties, providing strong guarantees for product reliability; The width of the edge has been increased, which better ensures the electrical insulation distance at the edge and overcomes the phenomenon of partial discharge; The design of the lead out terminal has anti rotation and anti stretching functions, and is filled with medium temperature thermal conductive epoxy resin (UL 94V-0) internally, without leakage and cracking.

Each power unit has complete protection functions (overcurrent, overvoltage, overheating, communication abnormalities, etc.), and the status of each unit is fed back to the main control system. Fiber optic communication technology is used between the controller and the power unit, and the low-voltage and high-voltage parts are completely reliably isolated. The system has extremely high safety and good resistance to electromagnetic interference.

The power unit structure is completely consistent, with a modular design that allows for arbitrary interchangeability of power units. The external interface of the unit only has two or four output terminals and two fiber optic sockets, making maintenance and repair easier. In the case of other power units malfunctioning when there is already redundancy in the unit, users can simply replace the backup power unit, winning valuable time for resuming production.

Each unit achieves sine PWM control through IGBT inverter bridge, and the output waveform of the unit can be obtained as shown in Figure 4.9.

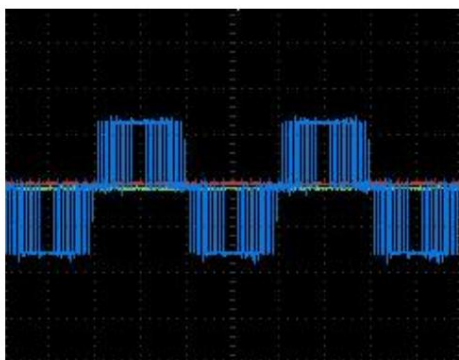

Figure 4.9 Unit output waveform

After unit connection, the three phases are connected in a star or angle shape and connected to the power grid through reactance. By overlaying the PWM waveforms of each unit, a stepped PWM waveform that approximates the sine can be obtained, as shown in Figure 4.10, which is a single-phase waveform of 10kV star connection.

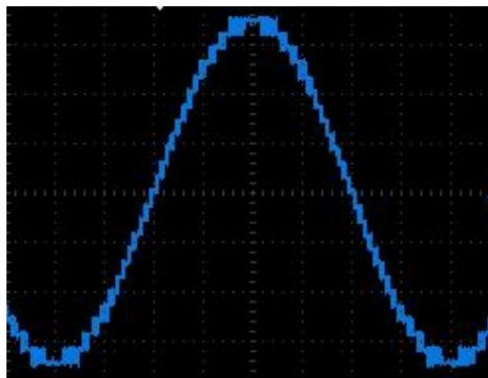

Figure 4.10 Waveform diagram after superposition of unit output

The LEHSVG series products adopt advanced digital standard carrier phase-shifting technology. Its characteristics are that the fundamental wave of the unit output is superimposed, the harmonics cancel each other out, and after being connected in series, it is filtered by an output reactor. The total output waveform has good sine degree, low dv/dt , and low harmonic content, which can reduce insulation damage to the cable. There is no need to add an output filter on the output side.

4.3 Reactor cabinet



Figure 4.11 Iron reactance in the LEHSVG reactor cabinet (for reference only)

The LEHSVG series products are connected to the power grid through reactors, resulting in better sinusoidal current waveforms. At the same time as smoothing the reactor, it also suppresses the harmonics of LEHSVG, making its output current harmonics comply with national standards. The separate design of the reactor cabinet is beneficial for users to have a higher utilization rate of space, greatly alleviating the limitations of space on the use of the equipment, reducing user investment in equipment to a certain extent, and saving expenses.



Figure 4.12 LEHSVG air-core reactor (for reference only)

Some models use air-core reactors, which are placed separately without reactor cabinets.

4.4 Control cabinet



Figure 4.13 LEHSVG control cabinet (for reference only)

The control part consists of a main control box, IO box, HMI, switch power supply, relay, filter, air switch, and a self-developed uninterrupted secondary power supply system.

Serial communication is used between the main control box and PLC, as well as between the main control box and the human-machine interface. The communication connection between the main control box boards realizes hierarchical control of the system, achieving the desired control objectives, monitoring the operating status of LEHSVG, and communicating with the upper computer.

1) Main control box

The main control box series standard chassis independently developed by our company has passed the strict EMC (electromagnetic compatibility) certification required by the GB/T 17626 series of national standards, and has been processed through temperature shock and vibration tests, demonstrating extremely high reliability. It contains power boards, main control boards, phase separation boards, signal separation boards, and other circuit boards, achieving plug-in interconnection, high uniformity, good stability, and easier maintenance. The power board provides various types of power supplies and interfaces for each circuit in the main control box, achieving data transmission between each circuit; The main control board implements core control, coordinates the work of various boards, and communicates with the outside world; The phase separation board and signal separation board achieve real-time monitoring of each unit module. The front view of the main control box is shown in Figure 4.14.



Figure 4.14 LEHSVG device control box (for reference only)

The control core in the main control box is achieved through the collaborative operation of a 32-bit high-speed digital signal processor DSP and a large-scale programmable logic device CPLD/FPGA. A carefully designed algorithm can ensure that LEHSVG achieves optimal operational performance. The controller adopts large-scale integrated circuits and surface welding technology, utilizing automated welding equipment for ICT and FCT detection, greatly eliminating the unstable impact caused by manual participation, and the system has extremely high reliability.

2) Logic control part

The reliable logical processing of switch signals inside the cabinet, as well as the coordination with various operational and status signals on site, enhances the flexibility of the system.

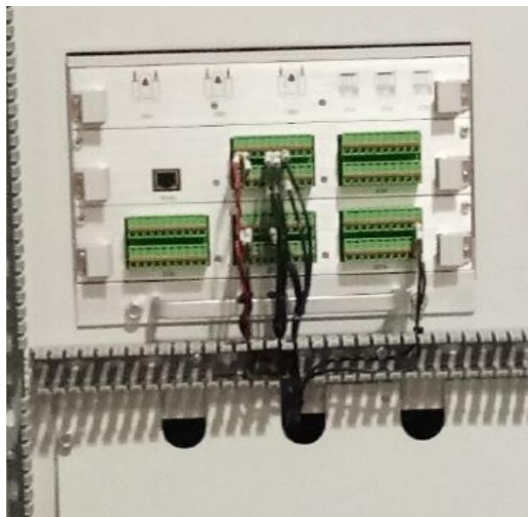

Figure 4.15 IO box (for reference only)

Real time communication with the main control part and HMI, real-time transmission of the device's operating status to HMI display, and accurate and rapid control of the device by HMI and cabinet door buttons.

3) Humanized operation interface

An emergency stop button is designed on the cabinet door to facilitate user operation in emergency situations. We choose the well-known domestic brand Weilun Tong HMI, and the supplier adopts the world's advanced instruments and equipment. We use standardized operating procedures to implement control, synchronize with international standards, and pass the 9001-2000 certification of the quality management system of an internationally renowned certification company.

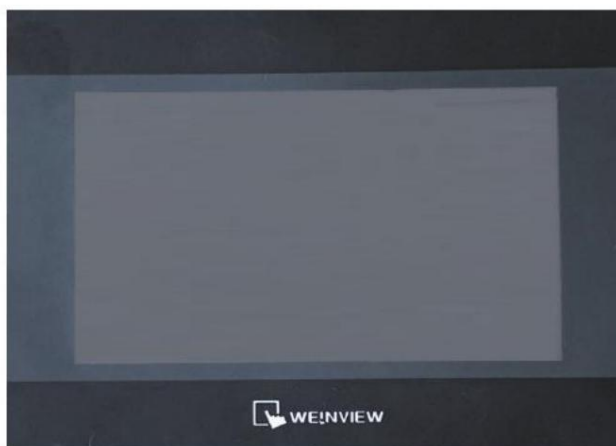

Figure 4.16 HMI selected by LEHSVG (for reference only)

LEHSVG adopts this type of HMI, providing a friendly all Chinese monitoring and operation interface. It adopts advanced human-machine communication skills to achieve free control of equipment start and stop operations.

HMI mainly provides the following functions:

- Self check the system;
- Basic operation of equipment and devices;

- One click on/off function;
- Time sharing control function;
- Oscilloscope function (forced recording of AD waves with different channels and magnifications)
- Fault recording, recording of voltage and current waveforms at the moment of fault;
- Real time status and analog display (voltage, current, temperature, power, power factor, etc.);
- Query of historical event records and historical curve records during operation;
- Chain device unit status monitoring;
- System information inquiry, parameter inquiry, and parameter setting, etc;
- Fault inquiry and historical fault inquiry.

4.5 Cooling system

The power cabinet part of LEHSVG reactive power compensation device adopts forced air cooling or water cooling system for forced cooling.

4.5.1 Forced air cooling for heat dissipation



Figure 4.17 Cabinet top fan for forced heat dissipation (for reference only)

4.5.2 Water cooling forced heat dissipation

The heat carrying pure water output from the unit enters the water-cooled unit, which is degassed by the gas-water separator and pressurized by the circulating pump. The water volume entering the heat exchanger is intelligently adjusted through an electric proportional valve to ensure that the water-cooled unit outputs cold pure water at the rated temperature, pressure, and flow rate. Finally, it returns to the unit for re heat absorption, and so on, forming a closed circulating cooling circuit.

The water cooling system includes the water cooling system host (including monitoring system), water cooling pipes, water-air heat exchange device and necessary support frames and accessories.

pieces etc.

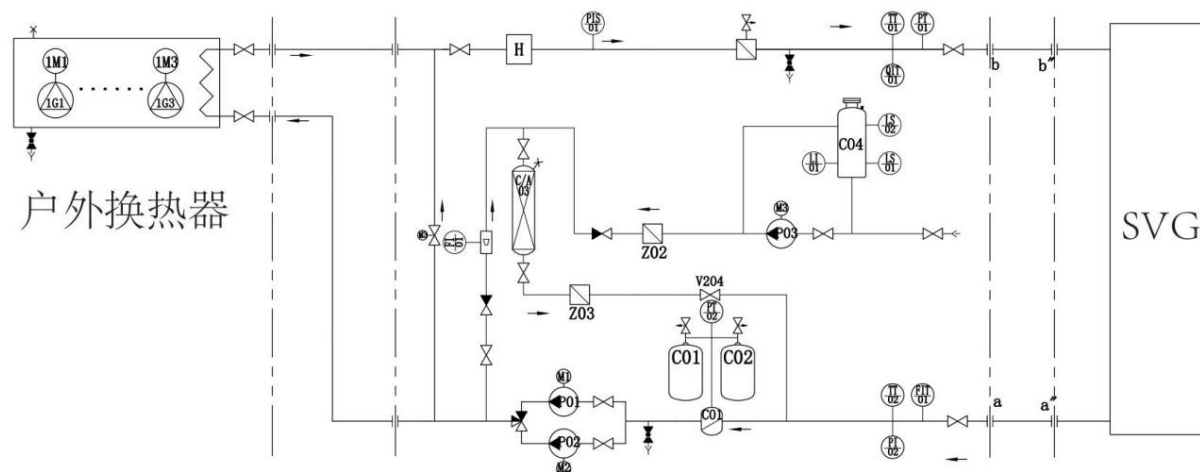

Figure 4.18 Water cooling system diagram (for reference only)

4.5.3 Water-cooled control cabinet



Figure 4.19 Water-cooled control cabinet (for reference only)

The water cooling control system adopts a cabinet structure design, and the main circulation pump is the power source of the pure water cooling device. This design adopts a vertical multi-stage centrifugal pump, and the pump unit is composed of optimized hydraulic components, various different connectors, and other components. In order to improve system reliability, a dual circulation pump is selected, with one in use and one standby. Its alternating usage is as follows: firstly, scheduled shift switching (168 hours, controllable switching period); One is to automatically switch based on the water flow rate detected by the control system when there is a malfunction.

4.5.4 Water-to-air heat exchanger



Figure 4.20 Water-cooled water-air heat exchanger (for reference only)

The heat carrying medium enters the water air heat exchanger and is carried away by forced air, achieving the purpose of heat exchange. The heat exchanger adopts a plate fin heat dissipation method, with a simple and compact overall structure, which can ensure that pure water is evenly distributed in the aluminum plate cavity. There are plate fins distributed between each plate cavity. When the fan is running, air is sucked in and flows through the gaps between the plate fins, taking away heat and cooling the main circulating water.

4.5.5 Water cooling piping system



Figure 4.21 Water cooling piping system (for reference only)

The external stainless steel pipes and pipe components (flanges, proportional valves, elbows, valves, joint seats, etc.) are welded and processed into a pipeline system, using automatic argon arc welding and fine polishing technology. The external surface is smooth and bright, without visible spots, and the internal surface is cleaned and passivated multiple times, all of which have passed the water pressure resistance test.

Chapter 5 Introduction to Touch Screen (HMI)

5.1 HMI system framework

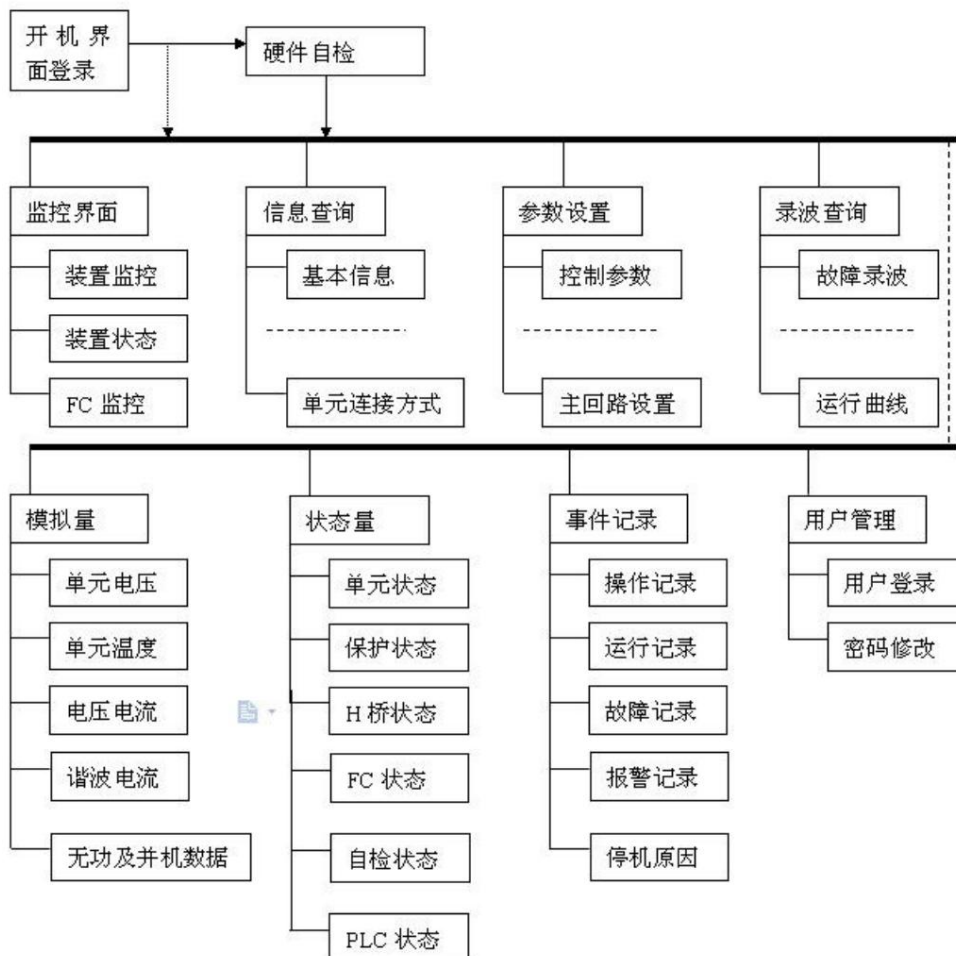

Figure 5.1 HMI architecture

5.2 HMI page function introduction

- 1) Device monitoring page: Displays system and device power parameters and operations on the entire machine such as opening and closing, starting and stopping.
- 2) Unit voltage page: displays the bus voltage of each unit.
- 3) Unit temperature page: displays the temperature of each unit in real time.
- 4) System data page: displays system, device, load voltage, current, power and other information.
- 5) Harmonic current page: displays the magnitude of each harmonic current of each phase.
- 6) Parallel data page: Displays information related to dual-machine parallel settings.

- 7) Unit status page: displays the status of each unit.
- 8) Protection status 1 page: displays information such as high-speed communication faults and complete machine faults.
- 9) Protection status 2 page: Displays information such as carrier configuration failure and H-bridge configuration failure.
- 10) Protection status 3 page: displays information such as communication failures and power failures.
- 11) Self-test status page: displays self-test fault information.
- 12) Operation record page: displays the start and stop operation records.
- 13) Operation record page: displays the power information during operation.
- 14) Fault record page: displays the fault type and alarm cause.
- 15) Downtime reason page: displays the reason for downtime.
- 16) Fault recording page: displays the voltage and current waveforms at the moment of the fault.
- 17) User change page: Change the identity of the logged in user.

5.3 HMI usage introduction

Control the power transmission, the user logs in (the logged in user's name is "ordinary user" and password is 0), and the device performs self check, as shown in Figure 5.2. If the self-test fails, the cause must be identified through a prompt. After the self-test passes, the monitoring interface will enter (as shown in Figure 5.3, the monitoring interface when the start and stop control is on the touch screen)



Figure 5.2 System self-test interface

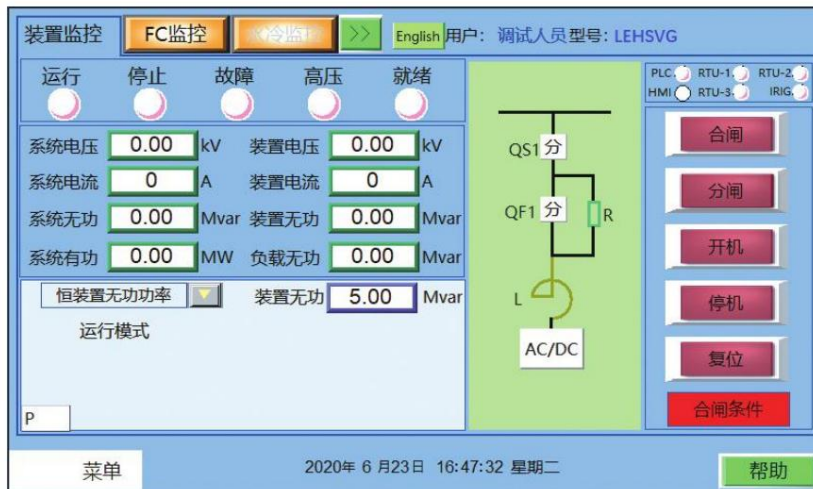

Figure 5.3 Device monitoring interface (local mode)

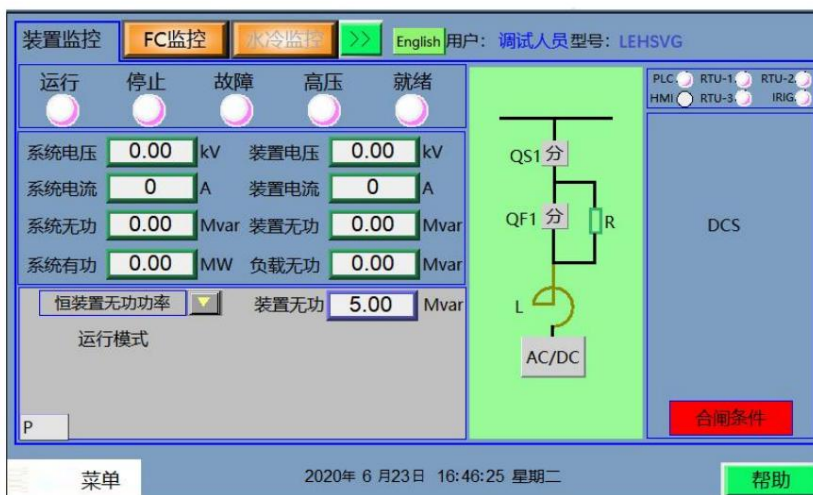

Figure 5.4 Device monitoring interface (remote mode)

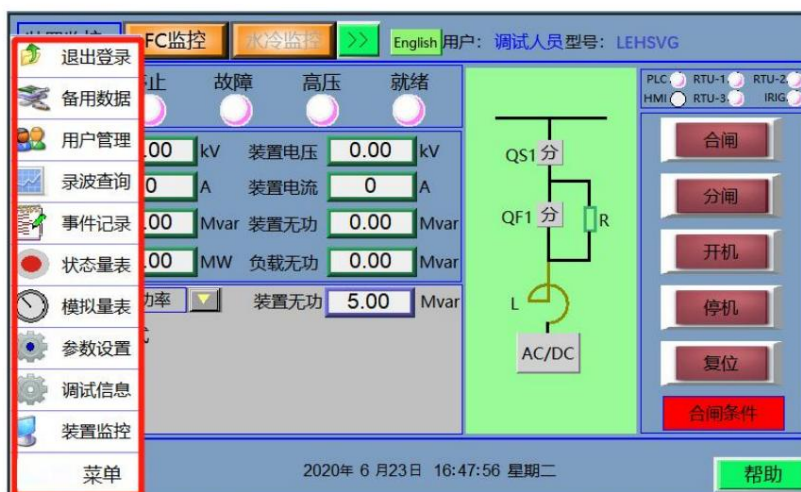

Figure 5.5 The red box in the figure indicates the menu selections for entering each sub-interface.

1) Analog quantity query: query analog quantities such as unit voltage, temperature (to be customized), harmonic current, device reactive power, and parallel machine data. Figure 5.7 shows the unit voltage display interface, and Figure 5.8 shows the unit temperature display interface.

编号	A相	B相	C相	编号	A相	B相	C相		
母线	和	0	0	0					MAX
1	0	0	0	11	0	0	0	A 1	0
2	0	0	0	12	0	0	0	B 1	0
3	0	0	0	13	0	0	0	C 1	0
4	0	0	0	14	0	0	0		
5	0	0	0	15	0	0	0		MIN
6	0	0	0	16	0	0	0	A 1	0
7	0	0	0	17	0	0	0	B 1	0
8	0	0	0	18	0	0	0	C 1	0
9	0	0	0	19	0	0	0		
10	0	0	0	20	0	0	0		

Figure 5.7 Unit voltage display interface

编号	A相	B相	C相	编号	A相	B相	C相		
1	0.0	0.0	0.0	11	0.0	0.0	0.0		MAX
2	0.0	0.0	0.0	12	0.0	0.0	0.0	相位	A
3	0.0	0.0	0.0	13	0.0	0.0	0.0	编号	1
4	0.0	0.0	0.0	14	0.0	0.0	0.0	温度	0.0
5	0.0	0.0	0.0	15	0.0	0.0	0.0		
6	0.0	0.0	0.0	16	0.0	0.0	0.0		
7	0.0	0.0	0.0	17	0.0	0.0	0.0		
8	0.0	0.0	0.0	18	0.0	0.0	0.0		
9	0.0	0.0	0.0	19	0.0	0.0	0.0		
10	0.0	0.0	0.0	20	0.0	0.0	0.0		

Figure 5.8 Unit temperature display interface

2) Status quantity query: Query the basic status of the unit, PLC input and output point status, etc. Figure 5.9 is the unit status interface (star-shaped connection)

	A	B	C
1			
2			
3			
4			
5			
6			
7			
8			
9			
10			
11			

Figure 5.9 Unit status interface

Note: If the unit status displays red or blue, it means that the unit is abnormal.

- 3) Fault recording: Figure 5.10 is the fault recording interface, which can record fault instantaneous voltage and current waveforms;
- 4) Fault recording: Figure 5.11 shows the fault recording interface, which can record specific fault information;



Figure 5.10 Fault recording interface



Figure 5.11 Fault recording interface

- 5) Water cooling system monitoring interface: Figure 5.12 is the display and control interface of the water cooling device, which can remotely control the start, stop and monitoring if water cooling device is correctly working.



Figure 5.12 LEHSVG touch screen water cooling control interface

Chapter 6 Storage and Installation

6.1 Overview

Our company adheres to the principle of quality first and user priority, and optimizes the design principles of LEHSVG. We strictly follow quality standards in various aspects such as device selection, production manufacturing, factory testing, and installation, ensuring high reliability and stable operation of the product under normal usage conditions.

6.2 Acceptance

A correct acceptance procedure consists of the following parts:

- Check the delivery list and make sure the equipment is complete
- Check for possible damage during transportation
- If there is any damage, take photos and leave evidence to file a claim with the transportation company.

6.3 Storage



Notice:

The air inlet and air outlet packaging can be removed before the equipment is powered on and running. Moisture-proof treatment is required when the equipment is not used for a long time. If it is not used for a long time, you need to use a heater to dry the power unit before powering it on for the first time!

Please also pay attention to the following points when storing:

 Notice
<ul style="list-style-type: none"> • Note that the conditions of the equipment placement environment should be basically consistent with the operating environment, that is, there should be no dust or water droplets in the placement environment.
<ul style="list-style-type: none"> • Humidity must not exceed 90%.
<ul style="list-style-type: none"> • The equipment should be covered with waterproof film to prevent water droplets and moisture from continuously entering and causing equipment malfunctions.
<ul style="list-style-type: none"> • Water absorbing materials should be placed inside the equipment.
<ul style="list-style-type: none"> • Regularly remove moisture from the equipment.
<ul style="list-style-type: none"> • Storage temperature: -30~+70 °C
<ul style="list-style-type: none"> • Relative humidity: monthly average not exceeding 90% (25 °C), without condensation;
<ul style="list-style-type: none"> • Impact (storage and transportation): Maximum 100 m/s²
<ul style="list-style-type: none"> • Environmental conditions: No corrosive, flammable, explosive or other hazardous materials

- Care must be taken during transportation. Rain, exposure, impact and upside down are strictly prohibited.

6.4 Mechanical installation

6.4.1 Environmental requirements

In order to ensure the long-term stable and reliable operation of LEHSVG series products, the following requirements should be made for the installation environment and electrical usage conditions of LEHSVG:

Installation Environment

 Notice
<p>The minimum ambient temperature for operation is -10 °C (indoor type)/-25 °C (outdoor type), and the maximum ambient temperature is 40 °C. The temperature change in the working environment should not exceed 5 °C/h. If the ambient temperature exceeds the allowable value, corresponding air conditioning equipment should be considered.</p>
<p>Space requirements: The minimum distance from the front of the device to the wall shall not be less than 1500mm, the minimum distance from the back to the wall shall not be less than 1000mm, the minimum distance from the side to the wall shall not be less than 1000mm, and the minimum distance from the top to the top of the equipment room shall not be less than 1500mm.</p>
<p>The change rate of relative humidity should not exceed 5% per hour to avoid condensation.</p>
<p>LEHSVG should not be installed in environments with significant dust, corrosive or explosive gases, conductive dust, and other air pollutants. If there is a similar environment on site, it is necessary to install air conditioning and do internal circulation in the air duct.</p>
<p>The allowable vibration conditions for the installation site of LEHSVG are: vibration frequency of 10Hz --150Hz. When LEHSVG may resonate due to the vibration of the installation platform, vibration reduction measures should be taken for the equipment to avoid resonance frequency.</p>

Electrical usage conditions

 Notice
<p>The LEHSVG control power supply is AC380V, AC220V, or DC220V power supply. Please refer to the wiring diagram of the random transportation for capacity. The continuous fluctuation deviation of AC voltage is +7% to -10%.</p>

6.4.2 Equipment appearance and cabinet loading, unloading and installation

Taking the 10kV/4Mvar LEHSVG water-cooled model as an example, its exterior front view is shown in Figure 6.1, and the exterior left view is shown in Figure 6.2. The exterior dimensions of the 10kV/4Mvar LEHSVG water-cooled model are 5200mm (length) × 2605mm (high) × 1400mm deep.

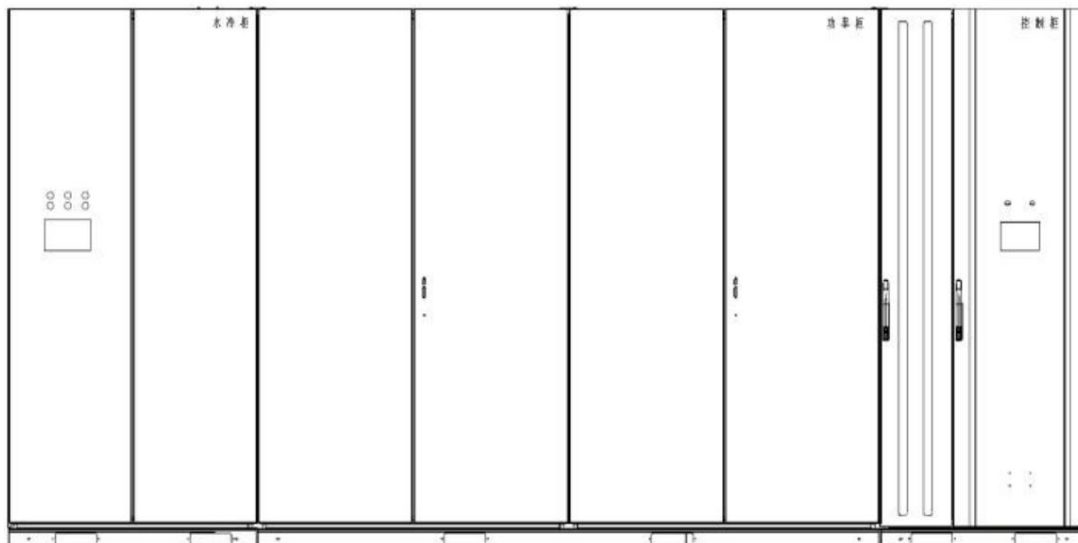

Figure 6.1 LEHSVG-10/4-W front view

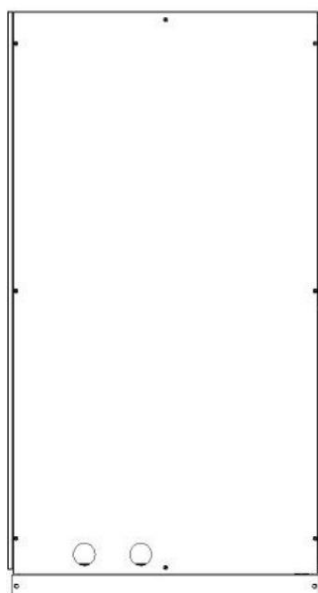

Figure 6.3 LEHSVG-10/4-W left view

When installing the LEHSVG series product equipment, consideration should be given to the needs of ventilation, heat dissipation, and operating space. The distance between the front of the entire device and the wall should not be less than 1500mm, the distance between the back of the device and the wall should not be less than 1000mm, and the distance between the left and right sides of the device and the wall should not be less than 1000mm, as shown in Figure 6.3. The distance between the top of the device and the roof space shall not be less than 1500mm.

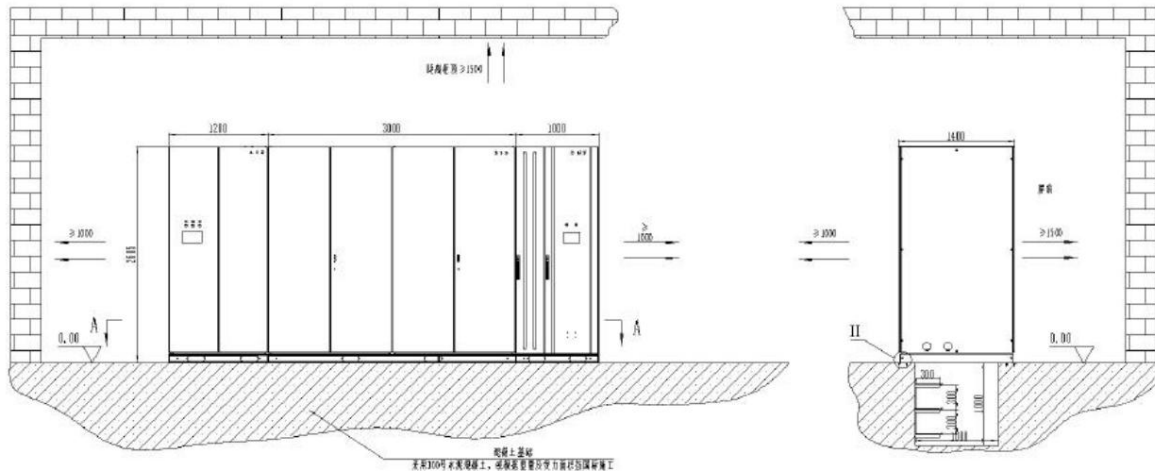

Figure 6.3 LEHSVG-10/4-W installation foundation diagram

All cabinets should be firmly installed on the base and reliably connected to the ground of the factory building. The shielding layer and grounding terminal PE of the device should also be connected to the ground of the factory building. The cabinets should be connected to each other as a whole and have reliable grounding (grounding resistance <math>< 500\text{m}\Omega</math>).

During the installation process, it is necessary to prevent the device from being hit and vibrated. All cabinets must not be inverted, and the tilt angle must not exceed 30° . The installation site of the device should take comprehensive small animal protection measures.

The LEHSVG series high-voltage dynamic reactive power compensation device is shipped separately with the control cabinet, power cabinet, and power unit during transportation. Power unit spare parts (if any) and fans on each cabinet top are packaged and transported separately.

The bases of each cabinet have forklift holes designed for the use of forklifts, which can be transported in the following ways:

1) Crane handling

Crane or chain hoist. It is best to use two metal beams of sufficient strength with a length not less than 1.5m, pass through the appropriate forklift holes on the cabinet base, and lift the front and rear ends with ropes of sufficient strength. Support the cabinet top with reinforced beams to prevent deformation of the cabinet body, as shown in Figure 6.4:

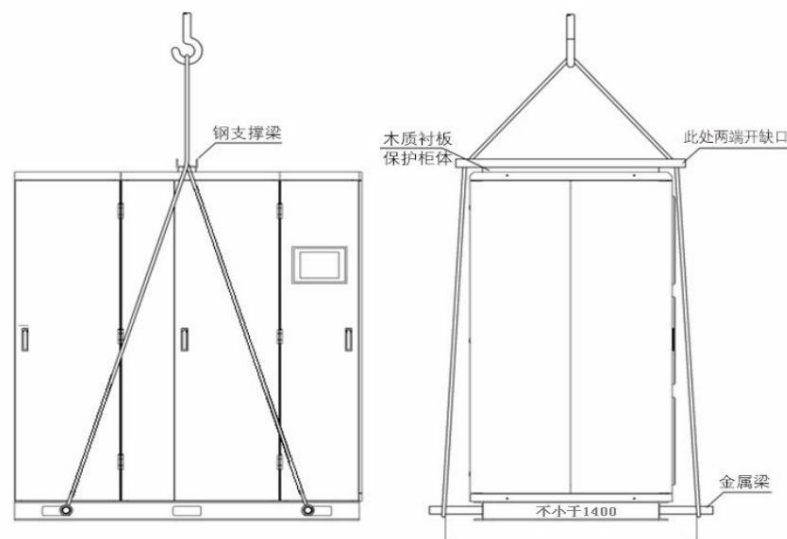

Figure 6.4 Bottom lifting and transportation diagram

Attention: When lifting, it is necessary to pay attention to the rope or metal beam passing through the appropriate forklift hole of the channel steel, and try to align the lifting center with the center of gravity of the lifted cabinet as much as possible, rather than the geometric center of the cabinet.

2) Forklift handling: When using a forklift for handling, the forklift must be able to bear the corresponding weight. The length of the forklift's shovel is not less than 1600mm, the width of the shovel is not more than 170mm, and the thickness is not more than 50mm. As shown in Figure 7.5:

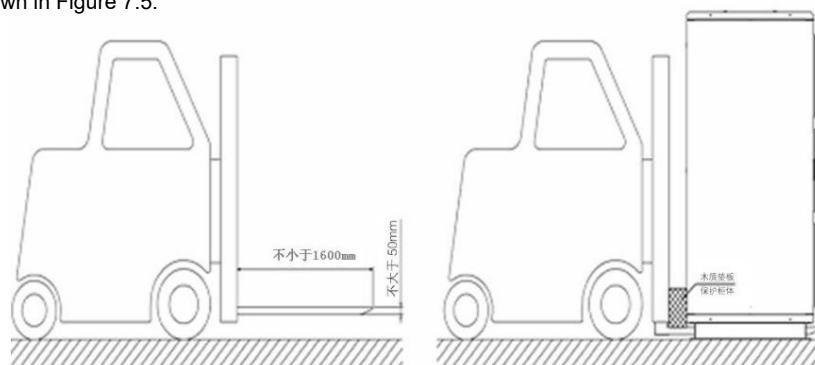

Figure 6.5 Forklift transportation diagram

Before using the forklift method of transportation, the blocking plates on the front and rear sides of the base need to be removed first, and the blocking plates must be replaced in their original positions after transportation.

6.5 Electrical installation

Electrical installation mainly includes the connection wires between cabinets, grid connected high-voltage cables and grounding cables from site to cabinet, AC or DC 220V and AC 380V control power cables from site to cabinet, and wiring of control and signal wires between site and cabinet.

6.5.1 High voltage cable connection

- Make sure the input voltage meets the requirements;
- Ensure that the cable diameter and voltage resistance meet the requirements;
- The input cable must be reliably connected to the terminal marked "three-phase input" at the rear of the control cabinet, as shown in Figure 6.8.



Figure 6.8 Three-phase main cable connection terminals

Note: If there are cable entry requirements at the user site, please specify the cable entry method in the technical contract. If not specified, press the cable entry method.

6.5.2 Ground cable connection

Try to choose a high-voltage cable with the same diameter as the input cable, and reliably connect the grounding terminal on the equipment base to the nearest grounding point on the user's site, ensuring that the grounding resistance is less than $500\text{m}\Omega$ to ensure the safety of equipment and personnel.

6.5.3 Control power cable connection

The equipment requires the user to provide a stable and reliable power supply (three-phase four wire AC380V, AC220V or DC220V power supply) on site. For power capacity and wiring specifications, please refer to the attached "LEHSVG Control Cabinet External Wiring Terminal Diagram". It is recommended that the user use a 5-core cable to provide 380V AC power supply for the cooling centrifugal fan.

6.5.4 Grid-side current signal sampling

- LEHSVG requires real-time sampling of the two-phase or three-phase grid side current information corresponding to the access point. Users should provide standard current signals of 0-5A or 0-1A with an accuracy of 0.2% -0.5%.
- Wiring method: According to the distance of the sampling point, it is recommended to use a two-core shielded cable with a thickness of 2.5mm^2 or more.
- Specific access point: refer to the random user drawing.

6.5.5 Load side current signal sampling

- LEHSVG requires real-time sampling of the two-phase or three-phase grid side current information corresponding to the access point. Users should provide standard current signals of 0-5A or 0-1A with an accuracy of 0.2% -0.5%.
- Wiring method: According to the distance of the sampling point, it is recommended to use a two-core shielded cable with a thickness of 2.5mm^2 or more.

- For specific access points, refer to the random user drawings.

6.5.6 Communication interface connection

- LEHSVG supports the communication function with the host computer. The communication adopts RS485 interface or Ethernet interface. The RS485 interface adopts Standard Modbus communication protocol, Ethernet communicates according to IEC-104 communication protocol.
- Wiring method: It is recommended to use multi-core shielded communication cables.
- Specific access point: refer to the random user drawing.

6.5.7 FC switching control interface wiring

- To meet the needs of more industrial sites and provide users with more economical and flexible compensation solutions, LEHSVG is designed to work in conjunction with FC to achieve effective coordination between fixed compensation and dynamic compensation. LEHSVG is equipped with 4 passive nodes, which can be used to control the 4-level FC switching on site. If additional switching levels are required, they need to be explained separately.
- For wiring method, it is recommended to use installation cables of 1.5 mm² or above or shielded cables for connection.
- For specific access points, refer to the random user drawings.

6.5.8 High voltage ready and joint tripped high voltage wiring

- To ensure the reliable and safe operation of the system, the superior switchgear should provide a passive node. After the switchgear provides high voltage, the LEHSVG device detects the high voltage through this node and enters the high voltage ready state.
- The LEHSVG device provides a passive node connected in parallel to the tripping circuit of the switchgear. When the LEHSVG actively exits or fails to exit operation, it provides a high-voltage status signal for continuous tripping, causing the higher-level switchgear to disconnect.
- For wiring method, it is recommended to use 1.5mm² installation cable or shielded cable for connection.
- For specific access points, refer to the random user drawings.

6.5.9 Precautions for electrical installation

- High-voltage cables must undergo strict withstand voltage tests.
- Non-professionals are not allowed to open the cabinet door for use or inspection.
- LEHSVG has undergone a withstand voltage test before leaving the factory. It is not recommended that users conduct a withstand voltage test on LEHSVG.
- It is not possible to change the three-phase input into a two-phase input.
- The signal lines connected to LEHSVG on site should be routed separately from strong current wires. It is best to use shielded wires for signal lines. One end of the shielding wire is reliably grounded.
- Always ensure reliable connection between the LEHSVG cabinet and the factory ground to ensure personnel safety.
- When the equipment is electrically installed, a special grounding electrode should be buried for the control system, and the grounding resistance is required to be no more than 500m Ω .
- After the wiring is connected, check carefully to ensure that the wiring is reliable and correct.
- Carefully check whether the LEHSVG capacity and connection specifications match, and whether the wires are intact.

6.5.10 Communication settings

In order to establish communication with the host computer, this device uses the standard MODBUS_RTU communication protocol and IEC60870-5-104.

To establish communication with the upper computer, this device uses standard MODBUS_RTU communication protocol and IEC60870-5-104. LEHSVG parallel operation relies on our company's mature communication mode to use fiber optic communication, ensuring the safe and reliable operation of parallel operation devices, improving the tracking speed of slave machines, and achieving the grid connection requirements of large capacity LEHSVG.

The human-machine interface of the cabinet door also provides a remote signaling and telemetry verification function for communication information when the device is not under high voltage, which facilitates on-site debugging personnel to test the communication data channel and data (see Figure 6.9).



Figure 6.9 "Four Remote" test interface



6.6 Fire protection requirements

 Notice
<p>The design of the equipment storage room must meet fire protection requirements.</p>
<p>It is strictly prohibited to pile any combustible or combustibile materials within at least 5m of the equipment placement site!</p>

6.7 Lightning protection and other requirements

 Notice
<p>The equipment storage room must have lightning protection measures that comply with the relevant lightning protection levels.</p>
<p>Regularly check the roof of the equipment room to prevent leakage from causing accidents or affecting the normal operation of the equipment.</p>

Chapter 7 LEHSVG debugging and use

 Notice	<p>Only trained and qualified personnel may operate the LEHSVG.</p> <p>Please strictly follow the instructions in the "Safety Instructions" in Part One during operation.</p>
 Notice	<p>The introduction in this chapter only takes our company's standard configuration LEHSVG control cabinet as an example. Different application requirements will lead to control</p> <p>The cabinet wiring principle has changed. Please refer to the introduction in this chapter and formulate your own operating procedures based on the actual wiring principle.</p>

7.1 Overview



Notice! After the LEHSVG equipment arrives at the site and the installation and wiring are completed, the equipment needs to be inspected before the control power and main power are connected.

Perform inspections, including primary loop and control loop, and ensure that all the following inspection items are correct before allowing LEHSVG to be powered on and started running.

Check name	Check item
Primary loop detection	The connection terminals of the primary circuit are reliable
	The unit copper bus connection is reliable and the fixing bolts are tight
	The equipment frame and power unit are not deformed or damaged.
	There are no cracks on the surface of insulators used inside the equipment.
	The equipment cabinet and other related grounding are in good condition
Control loop testing	Is the voltage of the control power supply normal?
	Are the communication fibers between the power unit and the main control box plugged in properly?
	Is the communication line with the backend normally connected?
	Is the feedback related to the switch cabinet normal?
	Are the relevant PT and CT signal connections normal?

7.2 Precautions when starting and stopping LEHSVG

- 1) Relevant operating procedures must be strictly followed when operating LEHSVG series products. Any wrong operation may cause personal injury and equipment damage.

- 2) LEHSVG is a high-voltage equipment. You must be aware of the dangers of high voltage during operation and strictly abide by the operation manual.
- 3) The relevant parameters in LEHSVG have been set before leaving the factory. If you do not have enough understanding of LEHSVG and the load system, Please do not change parameters at will, otherwise it may cause system abnormalities or even major accidents.
- 4) During normal operation, do not press the HMI or cabinet door operation buttons at will, otherwise it may cause system malfunction.
- 5) Operation and maintenance personnel of LEHSVG must undergo special training and should read this user manual carefully.
- 6) The rear part of the control cabinet, power cabinet, reactor cabinet, etc. of this product are all high-voltage hazardous areas and are strictly prohibited to open the door when high voltage is energized.
- 7) Important notes
 - The system voltage should be within $\pm 10\%$ of the rated nominal value.
 - The sequence of power transmission and power outage should follow: when transmitting power, control power should be sent first, and high-voltage power should be sent only after the control power is powered on normally; When powering off, cut off the high-voltage power first, and then disconnect the control power after the high-voltage power is discharged.
 - Users should monitor the operation status at any time during operation and shut down the machine in time when problems occur.

7.3 LEHSVG startup and shutdown steps

The main circuit of LEHSVG consists of multiple parts, including isolation switch QS1, contactor KM1 (or circuit breaker QF), buffer resistor R, and status detection device, as shown in Figure 7.1.

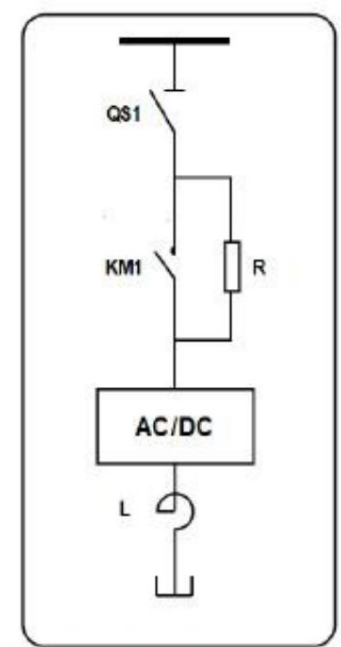

Figure 7.1 Main circuit diagram in the control cabinet (since each model is different, this diagram is for reference only)

Isolation switch QS1 is a safety protection device used to isolate the high voltage of the on-site power grid during system maintenance to ensure personal safety. The operation of isolation switch QS1 must be carried out after confirming the disconnection of the upper level switchgear, and it is not allowed to operate when the high voltage is delivered.

The starting method of the LEHSVG series products is designed to be manual closing, with the isolation switch QS1 closed, and the system grid charging the capacitors of the power module through buffer resistors. After the voltage of the unit bus reaches stability, close the contactor KM1 (or circuit breaker QF), bypass the buffer resistor, and complete the main power process of the entire machine.

In order to ensure that the LEHSVG device can operate in the optimal state on site, the parameters of the device have been optimized during company and on-site debugging. Please do not make any necessary changes. If there are any changes to the system, please consult our company. For parameters that need to be modified, authorized personnel should make corresponding changes based on the consultation results.

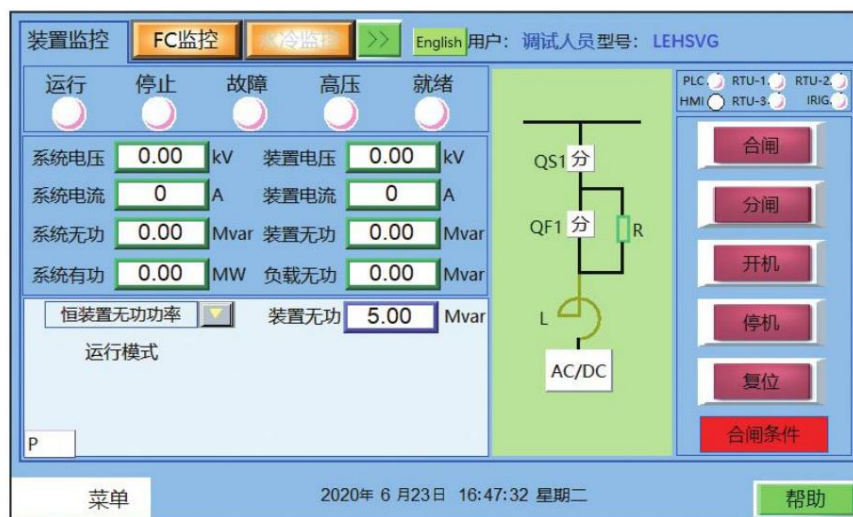

Figure 7.2 Monitoring interface

Start and stop are completed in the monitoring interface in Figure 7.2 (when the start and stop control is selected as the human-machine interface, it is same if it is a remote or background control step and

Power on steps: Set the required operating mode of the device → Turn on the closing condition interface green → Click on the closing button → Click on the power on button.

Shutdown steps: click the shutdown button → click the opening button



Notice! During the power-on process, the operation must be strictly carried out in accordance with the operation ticket regulations, and dangerous operations are strictly prohibited!

The detailed power-on process is as follows:

- 1) Before performing the LEHSVG operation, please confirm that the superior switchgear trolley has been shaken out and that the LEHSVG high opening cabinet ground switch is in a closed state, that is, the switchgear is in a cold standby state.
- 2) According to the wiring and installation instructions, conduct a detailed inspection of the secondary circuit section, and only proceed with the next step of power supply control after confirming that there are no errors.
- 3) The customer's on-site distribution room will send AC380V (three-phase four wire distribution system) power or DC220V power to LEHSVG to supply power to the LEHSVG secondary control system. Figure 7.3 shows the power switch configuration inside the LEHSVG control cabinet, where QF1 is the AC220V power air switch, QF2 is the DC220V power air switch, and QF3 is the power cabinet cooling fan power air switch.
- 4) Turn the QF1 and QF2 air switches to the closed position to supply power to the LEHSVG secondary control system. After powering on, the HMI (human-machine interface) will enter the startup mode.

According to the authorized user level (ordinary user), enter the corresponding password, and LEHSVG will enter the self check screen. After passing the self check, the HMI will enter the device monitoring interface, and perform corresponding operations through the status box status and relevant prompts on this interface, as shown in Figure 4.3.

5) Close the air switch QF3 of the LEHSVG control cabinet fan power supply. After the power is delivered, press and hold the AC contactor KM2 protruding on the control fan (as shown in Figure 7.3. If there is no model with this contactor, please contact our after-sales personnel for fan turning test under their guidance) or the corresponding contactor's moving iron core for about 2 seconds, release it, and observe whether the fan turning is consistent with the icon. If inconsistent, adjust the phase sequence of any two phases.



Figure 7.3 Control cabinet layout

6) Close all cabinet doors of the device, check the status of the main circuit isolation switch, and close the LEHSVG isolation switch in the cold standby state of the superior switchgear, as shown in Figure 7.3.



Figure 7.4 Operating lever position when the isolating switch is closed

- 7) If the equipment is a water-cooled model, it is necessary to ensure that the water-cooled system is in automatic operation mode and that the water-cooled monitoring interface in the LEHSVG touch screen shows that the water-cooled operation is normal before preparing to send high-voltage electricity.
- 8) Shake the upper level switchgear trolley in according to the regulations, and the switchgear will be put into a hot standby state, ready to send main power to the LEHSVG device.
- 9) During the main power transmission process, there are staff present in the backend control room and LEHSVG installation room to observe the device and report its status to each other. If any abnormal phenomena occur during the power transmission process, please promptly disconnect the LEHSVG higher-level high-voltage switchgear.
- 10) After the main power is sent to LEHSVG, each power unit starts working and performs self check. The "High Voltage" light on the HMI device monitoring page lights up, indicating that the main power has been delivered and the next step can be taken. The background color of the "closing condition" on the HMI device monitoring page has changed to "green", indicating that closing is allowed; If it shows red, it is not allowed to close. Click on "Close Condition" to check and process the items that display red in the pop-up window.
- 11) Check if the unit bus voltage displayed on the HMI "Bus Voltage" page is evenly distributed (with the same difference value<140V). Loosen the cabinet door emergency stop (as shown in Figure 7.5), press the "Close" button on the device monitoring page, and the device will enter the ready state from the charging state. At this time, the "Ready" light on the device monitoring page will light up.



Figure 7.5 Cabinet door emergency stop

- 12) Select the operating mode from the dropdown menu, set the control target in the input box, and then start the machine.
- 13) If there is a malfunction in the unit or system, the "Fault" light on the HMI device monitoring page will light up, and the control cabinet door alarm light will periodically sound an alarm. LEHSVG will automatically shut down and disconnect the main grid connected switch of LEHSVG itself. If the fault is set with a trip function, the higher-level switchgear circuit breaker will trip together. After troubleshooting, click the "Reset" button on the device monitoring page to reset the LEHSVG, and then the LEHSVG can be restarted.



Notice! During shutdown and power outage, operations must be strictly carried out in accordance with the operation ticket regulations. Dangerous operations are strictly prohibited!

The detailed shutdown and power outage process is as follows:

- 1) Click the "Stop" button on the HMI device monitoring page, LEHSVG will stop normally, and LEHSVG will switch from running status to shutdown status, the "Stop" light is on..

- 2) Click the HMI "disconnect" button to disconnect the LEHSVG main switch. Attention: At this time, there is still high voltage in the main circuit, and it is prohibited to open the cabinet door.
- 3) Remote operation to disconnect the circuit breaker of the superior switchgear and switch the switchgear to hot standby
- 4) Manually shake out the upper level switchgear trolley, turn it to cold standby, and ground it.
- 5) Disconnect the LEHSVG isolation switch.
- 6) Observe the display of DC bus voltage in each HMI unit, wait for the DC bus voltage to drop to 0V, and then wait for 15 minutes. Then disconnect the power air switches QF1, QF2, and QF3 of the LEHSVG control cabinet.
- 7) Disconnect the LEHSVG AC380V, AC220V, or DC220V power switches in sequence in the distribution room.

7.4 LEHSVG operation mode

7.4.1 Operation mode

There are five operating modes: constant device reactive power mode, constant assessment point reactive power mode, constant assessment point power factor mode, constant assessment point voltage mode, and constant assessment point reactive power mode. Select from the dropdown menu and set the target value on the right. The target value can be changed at any time, and the compensation effect can be checked based on the detection value after modification. As shown in Table 7.1 below, a detailed explanation of the "operating mode" is provided.

Table 7.1 LEHSVG system operation mode

Operation mode	illustrate
Constant device reactive power mode	LEHSVG fixedly transmits or absorbs the set amount of reactive power.
Constant assessment point power factor mode	Within the LEHSVG compensation capacity range, the assessment point is based on the set power factor (-1~+1) target to compensate.
Constant assessment point voltage mode	Targeting the voltage value set by the user, the reactive power output is adjusted to stabilize the grid voltage near the set value.
Constant assessment point reactive power mode	By adjusting the reactive output of LEHSVG, the reactive power at the assessment point is stabilized near the set value.
Constant assessment point reactive power mode 2	This mode detects the reactive power on the load side and adjusts the reactive power of LEHSVG to make the system side reactive power zero or stable at the set value.

Chapter 8 LEHSVG Maintenance Precautions

The LEHSVG series products have been designed with full consideration for the safety of operators, but like any other power device, there are high voltages on many internal terminals that can be fatal. In addition, the temperature of the radiator and other internal components is high, so it is necessary to strictly follow safety guidelines when contacting and operating LEHSVG.

 Danger
<ul style="list-style-type: none"> • Users must receive training, be familiar with the structure of LEHSVG, and master practical operational knowledge and precautions. Only personnel who have received the above training are allowed to operate, maintain, and repair LEHSVG.
<ul style="list-style-type: none"> • During maintenance, strictly adhere to the operation ticket system, ensure that the isolation switch on the LEHSVG control cabinet is disconnected, and other supervisors are present.
<ul style="list-style-type: none"> • You can only touch the components inside the cabinet when the device is not powered (high-voltage power and control power) and there is no high temperature.
<ul style="list-style-type: none"> • High-voltage operating procedures must be followed during maintenance, such as wearing insulating gloves, insulating shoes, and safety glasses.
<ul style="list-style-type: none"> • Install a safety guardrail (marked with high voltage hazard) and do not use it for other purposes during use.
<ul style="list-style-type: none"> • It is prohibited to place flammable materials (including equipment drawings and user manuals) near the LEHSVG.
<ul style="list-style-type: none"> • Use caution when handling or measuring components within the device, and be careful not to allow instrument leads to interconnect or contact other terminals.
<ul style="list-style-type: none"> • It is forbidden to disconnect the power supply of the cooling fan when the main circuit is powered, otherwise it may cause equipment failure.
<ul style="list-style-type: none"> • When transporting LEHSVG, the loading must be symmetrical and flat; when unloading, confirm that the ground used for placement is level.
<ul style="list-style-type: none"> • The user's fault maintenance is limited to recording the fault phenomenon and replacing the unit if necessary. Further repairs should be handed over to the manufacturer for processing.
<ul style="list-style-type: none"> • Unit replacement can only be performed after the main power supply of LEHSVG has been out for more than 15 minutes.
<ul style="list-style-type: none"> • Any incorrect operation may cause personal injury or damage to the LEHSVG.
<ul style="list-style-type: none"> • Observe other safety precautions mentioned in this manual to prevent personal injury, casualties and equipment damage.
<ul style="list-style-type: none"> • Various plug-ins for power-off plug-in devices.
<ul style="list-style-type: none"> • Do not touch the chips and devices on the printed circuit board.

- Use qualified testing instruments and equipment to test and inspect the device.
- Before operating the current transformer, ensure that its secondary side remains short-circuited. Do not disconnect the secondary side of a current transformer during operation.



- A system for recording equipment operating conditions and an application maintenance system should be formed.
- The product will inevitably collect dust and various impurities during use, and must be cleaned and maintained regularly, especially the power cabinet.
The air inlet window filter cotton must be cleaned regularly! It is recommended to clean once a month. If the environment is clean, the cleaning cycle can be extended appropriately.
- After a period of operation, the vibration of the fan and other mechanical vibrations may cause electrical contact components to loosen, leading to poor contact and even damage to components, components, and the entire machine, causing inconvenience and loss to users. Therefore, maintenance and cleaning checks are necessary after a period of use to avoid losses.
- Check whether the insulation of electrical equipment is damaged (such as the main circuit line), whether the buffer resistance is damaged, whether the cabinet door is intact, whether the protective neutral or protective grounding is correct, and whether the grounding impedance meets the requirements.
- After about a week of operation, shut down the machine, cut off the main power, and tighten the screws, bolts, and other parts of the conductive connection and grounding wire to meet the requirements of reliable contact.
- After being put into operation, the temperature measurement of the contact points should be repeated every quarter.
- After operation, a planned shutdown should be arranged once a year, and a power unit should be opened to inspect the capacitor. The thin film capacitor shell should have no abnormalities, and the sealing surface should be smooth and black in color. If any of the capacitors are abnormal, the manufacturer should be notified immediately for handling.
- Anti-rodent treatment is required indoors to prevent small animals from entering the LEHSVG cabinet.

8.1 Daily inspection items



warn! During inspection, do not get too close to live devices such as power cabinets and reactors.

- Check whether there are any abnormal vibrations, sounds, smells, or smoke near the equipment.
- Check whether there is any alarm message on the LEHSVG touch screen interface, and whether the relevant temperature and voltage display is normal.
- Check whether the primary and secondary cables are damaged, whether there is discharge sound in the cables, and whether the wiring bolts are loose.

<ul style="list-style-type: none"> • Check whether the filter cotton of the air-cooled LEHSVG power cabinet is clogged and whether there is abnormal vibration when the fan is running; water-cooled LEHSVG requires. Check whether the external radiator fan makes any abnormal noise or is blocked. After windy weather, observe whether there is a covering above the fan.
<ul style="list-style-type: none"> • Check whether there is water seepage/leakage in the water cooling system, and whether the pressure and flow are normal.
<ul style="list-style-type: none"> • Check whether there are any abnormal sounds from the reactor, circuit breaker, and isolation switch, and whether there are any foreign objects connecting them.
<ul style="list-style-type: none"> • Pay attention to maintaining the indoor temperature. When the indoor temperature is higher than 38℃, you should try to cool down, such as strengthening indoor and outdoor ventilation, turning on the air conditioner, etc.
<ul style="list-style-type: none"> • Pay attention to keeping the room clean to avoid dust accumulation.

8.2 Regular maintenance items



warn!

During equipment maintenance, it is necessary to shut down the equipment, cut off AC and DC power sources, and wait for the DC bus of the power unit to power on

The operation can only be carried out when the pressure is reduced to a safe range, and the internal components of the equipment cannot be disassembled arbitrarily, otherwise it may cause equipment damage or even

Danger to personal safety. Regular maintenance is generally carried out every six months, and when the environmental conditions are harsh, the frequency of maintenance should be increased as appropriate.



warn! Maintenance precautions

<ul style="list-style-type: none"> • Irrelevant personnel are not allowed to operate, maintain, inspect, etc. this equipment!
<ul style="list-style-type: none"> • After the LEHSVG system is shut down, the DC bus of the power unit still has residual voltage, and the capacitor must be fully discharged before the power can be regenerated. <p>Please perform maintenance on the power unit. Do not touch the inside of the unit before determining the correct DC bus voltage!</p>
<ul style="list-style-type: none"> • Do not use a high-voltage insulation resistance meter to measure the output insulation of the LEHSVG system, otherwise it will cause damage to the internal power electronic components of the power unit!
<ul style="list-style-type: none"> • To conduct a voltage withstand test on high-voltage cables, the power unit must be disconnected from the tested device. Testing the tested device separately will cause damage to the LEHSVG system!
<ul style="list-style-type: none"> • When conducting insulation testing on the LEHSVG system, all power unit terminals must be short circuited with wires to both ends of the DC side capacitor before testing. It is strictly prohibited to test a single terminal to ground, otherwise there is a risk of damaging the power unit's power electronic components!
<ul style="list-style-type: none"> • During the maintenance process, foreign objects should be prevented from falling into the equipment!

8.2.1 LEHSVG operating procedures from operation to maintenance

 warn!
<ul style="list-style-type: none"> • Stop the LEHSVG system and open the gate on the touch screen interface or background interface
<ul style="list-style-type: none"> • Open the LEHSVG switch cabinet to the separated position
<ul style="list-style-type: none"> • Pull the LEHSVG switch cabinet handcart from the working position to the test position
<ul style="list-style-type: none"> • Close the LEHSVG switchgear grounding knife
<ul style="list-style-type: none"> • Check that the LEHSVG switchgear switch grounding knife is in the closed position
<ul style="list-style-type: none"> • Hang a sign saying "Someone is working, closing is prohibited" on the switch and starter cabinet of LEHSVG switchgear.

8.2.2 LEHSVG operating procedures from maintenance to operation

 warn!
<ul style="list-style-type: none"> • Take back the "No closing when someone is working" signs hanging on LEHSVG switch cabinets and starter cabinets
<ul style="list-style-type: none"> • Open the LEHSVG switchgear grounding knife gate
<ul style="list-style-type: none"> • Check that the LEHSVG switch cabinet switch is in the position
<ul style="list-style-type: none"> • Push the LEHSVG switch cabinet handcart from the test position to the working position
<ul style="list-style-type: none"> • Turn the LEHSVG switch cabinet to the closing position
<ul style="list-style-type: none"> • Turn on the LEHSVG on the touch screen interface or background interface
<ul style="list-style-type: none"> • Check whether the LEHSVG system is running normally

8.2.3 LEHSVG operating procedures from operation to maintenance

maintenance location	maintenance items
surroundings	<ul style="list-style-type: none"> • Check the ambient temperature and humidity
	<ul style="list-style-type: none"> • Remove dust, oil and water droplets from the operating environment
	<ul style="list-style-type: none"> • Remove foreign objects and dangerous goods around the cabinet
Power unit	<ul style="list-style-type: none"> • Check whether the heat dissipation channel is unobstructed

	<ul style="list-style-type: none"> • Check whether the incoming and outgoing cables and connecting copper bars are loose or burnt. If any are loose, tighten them
	<ul style="list-style-type: none"> • Remove dust on the power unit
Cabinet and fan	<ul style="list-style-type: none"> • Check whether the cabinet is deformed or stained, and whether the fasteners are loose.
	<ul style="list-style-type: none"> • Remove dust and foreign matter on the surface and inside of the cabinet
	<ul style="list-style-type: none"> • For the air-cooled LEHSVG system, it is necessary to remove the dust from the power cabinet filter screen; The water-cooled LEHSVG system needs to clean the dust on the outdoor radiator fan
Cables and wiring	<ul style="list-style-type: none"> • Check whether the conductor wire is discolored, deformed or damaged
	<ul style="list-style-type: none"> • Check whether the connection between terminal block and cable is loose.
Cooling system	<ul style="list-style-type: none"> • Check whether there is water seepage/leakage in the water cooling system and whether the pressure and flow are normal.
	<ul style="list-style-type: none"> • Check the operating noise and temperature of the main circulation pump motor and fan motor;
	<ul style="list-style-type: none"> • Check if the inlet valve temperature, outlet valve temperature, water pressure, water level, conductivity, and flow rate of the water cooling system are normal, and check if the heat exchanger is blocked

Chapter 9. Handling of Frequently Asked Questions

9.1 Overview

After a unit failure or system failure occurs in the LEHSVG series products, the system will automatically record the fault information. Once a malfunction occurs, the system will alarm and automatically trip and shut down. Only after the fault is completely eliminated can it be restarted.

When a fault occurs, the LEHSVG grid connected main switch will automatically disconnect. If the main switch is not turned off due to other special reasons, users can use the "emergency stop" button on the cabinet door to manually turn off the main switch.

9.2 Common problems and solutions

LEHSVG has a high level of intelligence and a complete fault detection circuit, and can provide accurate positioning for all faults, making clear instructions on HMI pages. Users can take corresponding measures based on the fault information displayed on the HMI.

The main control software and hardware detect faults and alarms and store them in the control system memory. Faults can be directly detected hardware faults or generated by software. Unit faults are detected by the control system within each power unit, and each power unit has its own detection circuit. The main control system interprets, displays, and records unit faults based on the faulty unit and its content.

Usually, all faults will cause LEHSVG to immediately shut down, disconnect the main switch for grid connection, and provide a signal for tripping the upper switchgear. Users can define some minor faults that do not affect the normal use of LEHSVG. When such faults occur, alarms will be displayed and recorded, but LEHSVG will continue to operate. Please refer to Table 9.1 for the protection reasons, protection types, and handling strategies for general faults.

Table 9.1 Troubleshooting measures

Failure/Exception	possible reason	Corresponding countermeasures
PLC communication failure.	The connection line between the main control and the PLC is in poor contact.	Check the condition of the connecting wires and check whether the pins are corroded
HMI communication failure	The connection line between the main control and HMI is in poor contact.	Check the connection of 485 communication line
Cabinet door status failure	Cabinet door open	Check whether the cabinet door is closed and adjust the process switch position
Unit overtemperature	1) The fan does not rotate or reverses 2) There is too much dust on the cabinet door filter and poor ventilation. 3) The air duct is not tightly closed	1) Check the fan 2) Clean the cabinet door filter 3) Check the air duct and take sealing measures.

Unit overvoltage	1) Communication failure occurred in the communication part after sampling the voltage of the unit bus	1) Check the internal wiring connection of LEHSVG.
	2) Excessive electromagnetic interference on site causes malfunction	2) Take shielding measures.
System overvoltage	may cause grid failure	Waiting for recovery, reset.
Unit overcurrent	1) Unit overcurrent error protection	1) Power on again and turn on the machine after reset
	2) System voltage failure, causing sudden changes	2) Wait for automatic recovery
System overcurrent	1) System voltage malfunctions, causing mutations;	1) Observe whether there are any abnormalities in system voltage and load impact;
	2) LEHSVG operating capacity is too high and overloaded	2) Wait for LEHSVG to automatically reset;
		3) Check that the wiring of the LEHSVG output current transformer is Is it correct? Is the current direction defined correctly?

9.3 How to replace a faulty unit

If a unit cannot function properly due to a malfunction, you can contact our company to purchase a power unit of the same model. Replace the faulty unit with this unit when LEHSVG is shut down and the main power is cut off.

1) Steps for replacing faulty units in air-cooled units:

Step 1: Stop the LEHSVG and press the emergency stop button on the control cabinet door;

Step 2: Operate the higher-level switchgear to the cold standby state and disconnect the isolation switch of the LEHSVG body at the same time;

Step 3: Observe the HMI unit bus display, confirm that the unit bus voltage has changed to 0V, wait for 15 minutes, and disconnect QF1, QF2, and QF3;

Step 4: Open the door of the power cabinet, unplug the fiber optic head of the faulty unit, cover the fiber optic cap, and do a good job of dust prevention;

Step 5: Pull out the faulty unit along the track (do not touch the optical fiber) and handle it gently; For small capacity LEHSVG, the fastening bolts at the back of the unit need to be loosened.

Step 6: Push units of the same model along the track and connect the cables/copper bars and optical fibers according to the original connection method;

Step 7: According to the operation manual, after checking that there are no problems, the system will be re powered and put into operation;

Step 8: Contact the manufacturer to repair the faulty unit.

(2) When replacing a faulty unit with a water-cooling unit, follow the following steps:

Step 1: Stop the LEHSVG and press the emergency stop button on the control cabinet door;

Step 2: Operate the higher-level switchgear to the cold standby state, while disconnecting the isolation switch of the LEHSVG body and ensuring reliable grounding of the grounding switch;

Step 3: Observe the HMI unit bus display, confirm that the unit bus voltage has changed to 0V, wait for 15 minutes, and disconnect QF1, QF2, and QF3;

Step 4: Open the door of the power cabinet, unplug the fiber optic head of the faulty unit, cover the fiber optic cap, and do a good job of dust prevention;

Step 5: Control the water cooling device to stop, close butterfly valves V01 and V04, all circuit breakers, and disconnect the power supply;

Step 6: The water in the power cabinet pipeline can be drained through the drainage valve on the bottom pipeline inside the power cabinet. After opening the drainage valve to release some water, open the exhaust plug at the exhaust point to allow air to enter the pipeline and facilitate the pipeline to be drained as soon as possible;

Step 7: First, remove the external capacitor behind the unit that needs to be repaired. Next, remove the copper bar and fixing screws of the unit output. Then, remove the pipes connected to the front radiator and the communication fiber on the unit control board. Finally, keep the unit high in front and low in the back (to prevent residual water from the heat sink from splashing into other units);

Step 8: Perform unit maintenance or replacement;

Step 9: First, place the unit in place and install the fixing screws. Then, connect the unit output copper bar and external capacitor to fix them. Then, install the pipeline connected to the front heat sink and the communication fiber on the unit control board. Finally, tighten the screws that fix the unit and capacitor.

Step 10: Open butterfly valves V01 and V04, all circuit breakers, and perform system water replenishment and gas discharge. Turn on the water cooling device.

Step 11: According to the operation manual, after checking that there are no problems, the system will be re powered and put into operation;

Step 12: Contact the manufacturer to repair the faulty unit.

Attention: When dismantling the pipes connected to the radiator, first unscrew the unit's upper water nozzle, and then unscrew the unit's lower water nozzle; Install the drain nozzle first before installing the upper nozzle.

Chapter 10 Service and Warranty

- Pre sales service

Plan for users, propose suggestive system design ideas, and provide technical consulting services.

Propose installation plans and environmental requirements.

Estimate the operating effect.

- After-sale service

Free training for operators and always free consultation.

Free warranty during the warranty period (excluding damage caused by human error or incorrect operation).

No matter when and where we use our company's products, we offer a lifetime warranty.

- Warranty rules

Warranty scope

◇ The warranty scope refers to the LEHSVG device and accessories provided by our company;

In case of malfunction or damage during normal use, our company is responsible for free maintenance of the equipment within 12 months of normal operation.

Paid maintenance

Our company's warranty service commitment does not apply to the following situations:

Products or components that exceed the warranty period;

◇ External equipment, third-party products, components that are not installed or attached in our company's factory, and products or components provided by users;

◇ Failure or damage caused by installation, storage, and use (such as high temperature, low temperature, high humidity, unstable voltage or current, input of inappropriate voltage, operational errors, etc.) in a non specified working environment or other errors without the consent of our company, in accordance with product usage requirements;

◇ Failure or damage caused by installation, repair, modification, or disassembly not authorized by our company;

◇ Malfunctions or damages caused by components not supplied by our company;

◇ Malfunctions or damages caused by accidents or other external factors (including natural disasters, fires, floods, wars, violent acts, or similar events).